

# Operation Manual

## RM-911D/W Remote Microphone

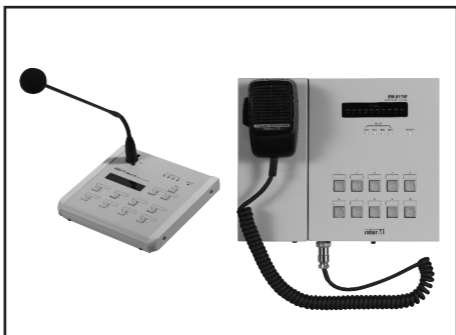

**interM**

# Warning

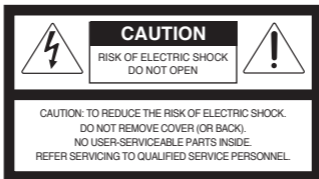

## WARNING

To prevent fire or shock hazard, do not expose the unit to rain or moisture.



This symbol is intended to alert the user to the presence of uninsulated "dangerous voltage" within the product's enclosure that may be of sufficient magnitude to constitute a risk of electric shock to persons.



This symbol is intended to alert the user to the presence of important operation and maintenance (servicing) instructions in the literature accompanying the appliance.

**Caution:** These servicing instructions are for use by qualified service personnel only. To reduce the risk of electric shock, do not any perform any servicing other than that contained in the operating instructions unless you are qualified to do so.

**Attentions:** Pour prévenir les chocs électriques ne pas utiliser cette fiche polarisée avec un prolongateur, une prise de courant on une autre sortie de courant, sauf si les lames peuvent être insérées à fond sans en laisser aucune partie à découvert.

\***WARNING FOR YOUR PROTECTION PLEASE READ THE FOLLOWING-WATER AND MOISTURE:** Unit should not be used near water(e.g. near a bathtub, washbowl, kitchen sink, laundry tub, in a wet basement, or near a swimming pool, etc). Care should be taken so than objects do not fall and liquids are not spilled into the enclosure through openings.

\*Do not install this equipment in a confined space such as a book case or similar unit.

\*This apparatus shall not be exposed to dripping or splashing and no objects filled with liquids, such vases, shall be placed on the apparatus.

\*This apparatus shall be connected to a mains socket outlet with a protective earthing connection.

\*It has heed to be easy to disconnect the device. To disconnect the device from power, separate AC input cable from inlet or unplug the AC Cord.

\***CAUTION :** These servicing instructions are for use by qualified service personnel only. To reduce the risk of electric shock, do not perform any servicing other than that contained in the operating instructions unless you are qualified to do so.

**NOTE :** This equipment has been tested and found to comply with the limits for a Class A digital device, pursuant to Part 15 of the FCC Rules. These limits are designed to provide reasonable protection against harmful interference when the equipment is operated in a commercial environment. This equipment generates, uses, and can radiate radio frequency energy and, if not installed and used in accordance with the instruction manual, may cause harmful interference to radio communications. Operation of this equipment in a residential area is likely to cause harmful interference in which case the user will be required to correct the interference at his own expense.

# Contents

Welcome .....	2
Unpacking .....	2
Short Form Instructions .....	3
Installation	
Environment.....	4
Important Safety Instructions .....	4
Features .....	6
Front Panel.....	7
Rear Panel .....	9
Operation Method.....	14
Connection .....	16
Block Diagram .....	17
Specifications .....	19
Dimension .....	20
Service	
Procedures.....	21
Schematic .....	21
Parts List.....	21
Variations and Options	
Variations .....	21
Options.....	21
Warranty.....	21

## Welcome

### **A personal welcome to you from the management and employees of Inter-M**

All of the co-workers here at Inter-M are dedicated to providing excellent products with inherently good value, and we are delighted you have purchased one of our products.

We sincerely trust this product will provide years of satisfactory service, but if anything is not to your complete satisfaction, we will endeavor to make things right.

Welcome to Inter-M, and thank you for becoming part of our worldwide extended family!

## Unpacking

Please take a few minutes to read this manual to familiarize yourself with important information regarding installation, product features, and operation.

As with most electronic devices, ORIGINAL PACKAGING (OR EQUAL) IS REQUIRED in the unlikely event that the product needs to be returned for servicing.

## Short Form Instructions

1. Connect the CAT-5E cable to the ARM-911. Be sure that the CAT-5E cable length must not longer than the maximum operable length.
2. The IN-USE LEDs are blinking and if the communication between RM-911 and ARM-911 is no problem, then blinking is off.
3. Select the CHIME mode and TALK mode switch as your preference. (RM-911D only)
4. Adjust the volume of monitor amp and adjust the output volume.
5. Connect to the ARM-911 network using the IP address of the ARM-911.  
Move to the RM password menu among the Administrator menu.
6. Select the RM password setting.  
Input the password for RM1, RM2, RM3 and RM4 respectively.
7. Press the password using the INSTANT PLAY Buttons of RM-911 and then press the button to broadcast the message.  
Check the LED of the button is lit and check the broadcasting message is correct.
8. Press the password using the INSTANT PLAY Buttons of RM-911 and then press the TALK button (RM-911D) or press the PTT button (RM-911W) and talk to the mic and check the voice is broadcasted.
9. Adjust the broadcasting volume of RM-911 using GUI.

# Installation

## Environment

Never place this product in an environment which could alter its performance or reduce its service life. Such environments usually include high levels of heat, dust, moisture, and vibration.

## Important Safety Instructions

1. Read these instructions.
2. Keep these instructions.
3. Heed all warnings.
4. Follow all instructions.
5. Do not use this apparatus near water.
6. Clean only with dry cloth.
7. Do not block any ventilation openings. Install in accordance with the manufacturer's instructions.
8. Do not install near any heat sources such as radiators, heat registers, stoves, or other apparatus (including amplifiers) that produce heat.
9. Do not defeat the safety purpose of the polarized or grounding-type plug. A polarized plug has two blades with one wider than the other. A grounding type plug has two blades and a third grounding prong. The wide blade or the third prong are provided for your safety. If the provided plug does not fit into your outlet, consult an electrician for replacement of the obsolete outlet.
10. Protect the power cord from being walked on or pinched particularly at plugs, convenience receptacles, and the point where they exit from the apparatus.
11. Only use attachments/accessories specified by the manufacturer.
12. Use only with the cart, stand, tripod, bracket, or table specified by the manufacturer, or sold with the apparatus. When a cart is used, use caution when moving



the cart/apparatus combination to avoid injury from tip-over.

13. Unplug this apparatus during lightning storms or when unused for long periods of time.
  14. Refer all servicing to qualified service personnel. Servicing is required when the apparatus has been damaged in any way, such as power-supply cord or plug is damaged, liquid has been spilled or objects have fallen into the apparatus, the apparatus has been exposed to rain or moisture, does not operate normally, or has been dropped.
- **AVOID EXCESSIVE HEAT, HUMIDITY, DUST AND VIBRATION**  
Keep the unit away from locations where it is likely to be exposed to high temperatures or humidity—such as near radiators, stoves, etc. Also avoid locations which are subject to excessive dust accumulation, or to vibration that could cause mechanical damage.
  - **AVOID PHYSICAL SHOCKS**  
Strong physical shocks to the unit may cause damage. Handle the unit with care.
  - **DO NOT OPEN THE CASE OR ATTEMPT REPAIRS OR MODIFICATIONS YOURSELF**  
This product contains no user-serviceable parts. Refer all maintenance to qualified Inter-M service personnel. Opening the case and/or tampering with internal circuitry voids the warranty.
  - **ALWAYS POWER OFF BEFORE MAKING CONNECTIONS**  
Always turn the AC mains OFF before connecting or disconnecting cables. This is important to prevent damage to the unit itself as well as other connected equipment.
  - **HANDLE CABLES CAREFULLY**  
Always plug and unplug cables (including the AC mains power cord) by gripping the connector, not the cord.
  - **CLEAN WITH A SOFT DRY CLOTH**  
Never use solvents such as benzine or paint thinner to clean the unit. Wipe clean with a soft, dry cloth.

## Features

- ❑ **DIRECT BROADCASTING OF EMERGENCY MESSAGE**  
By pressing one of 10 instant play buttons, message file can be directly played.
- ❑ **REMOTE CONTROL OF ARM-911**  
Using RM-911D/W, emergency message of ARM-911 can be controlled at remote place.
- ❑ **EMERGENCY BROADCASTING USING MIC**  
Using MIC of RM-911D/W, emergency voice broadcasting can be done at remote place.
- ❑ **TALK MODE (RM-911D ONLY)**  
Using mode switch, TALK mode can be set.
- ❑ **CHIME (RM-911D ONLY)**  
Using mode switch, Chime can be used.
- ❑ **MONITOR SPEAKER (RM-911D ONLY)**  
Chime and MIC voice can be monitored using installed monitor speaker.
- ❑ **EXTERNAL ADAPTOR (OPTION)**  
External Adaptor can be used to extend the operable cable length.  
When external adaptor is used the power consumption ARM-911 is decreased.



## Front Panel

- RM-911D



- RM-911W

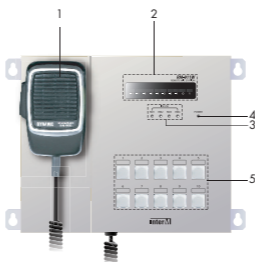

### 1. GOOSENECK MIC (RM-911D)/ PTT MIC (RM-911W)

Using Mic, emergency broadcasting can be done at remote place.

If password is set in the GUI, first press the password, and then press the TALK button (RM-911D) or press the PTT switch (RM-911W) to use the Mic.

If password is not correct or not inputted, then the Mic can not be used.

## **2. OUTPUT LEVEL LED**

Displays the output audio level.

## **3. IN-USE INDICATING LED**

Indicates the RM-911D/W which is now broadcasting using MIC.

## **4. POWER LED**

Indicates the power on state.

## **5. INSTANT PLAY BUTTON**

Pressing the one of 10 buttons can play the emergency message which is stored in the SD card of ARM-911.

If ARM-911 or RM-911D/W plays the one of 10 messages, then the corresponded button is lit. If the button which is lit is pressed in the one of 4 Remote Microphone (RM-911D/W), then broadcasting is stopped.

If password is set in the GUI, first press the password and then press the button to broadcast. If password is not correct or not inputted, then the IN-USE LED is blinking, the button does not lit and the message does not played.

## Rear Panel

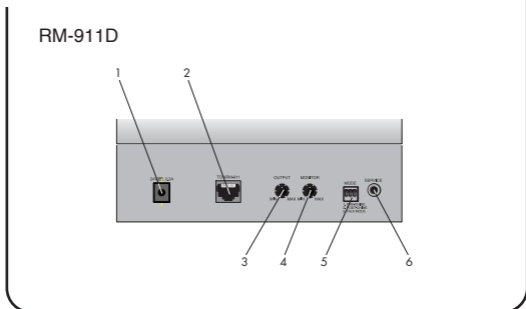

### 1. EXTERNAL ADAPTOR (OPTION) INPUT

Connect the external adaptor (OPTION) when it is needed.

The power is supplied by the ARM-911 if the adaptor is not used.

If the external adaptor is used, then the maximum operable distance can be extended and the power consumption of ARM-911 is decreased.

### 2. CONNECTING TERMINAL OF ARM-911

Connect to the ARM-911 using CAT5E cable.

The CAT5E pin description is as below.

Pin 1 : RS-422 RX+ (Refer to RM-911D)

Pin 2 : RS-422 RX- (Refer to RM-911D)

Pin 3 : RS-422 TX+ (Refer to RM-911D)

Pin 4 : DC24V

Pin 5 : GND

Pin 6 : RS-422 TX- (Refer to RM-911D)

Pin 7 : AUDIO HOT

Pin 8 : AUDIO COLD

### **3. AUDIO OUTPUT VOLUME**

The audio output volume is increased by turning the volume clockwise.

The audio output volume is decreased by turning the volume counter-clockwise.

### **4. MONITOR OUTPUT VOLUME**

The monitor output volume is increased by turning the volume clockwise.

The monitor output volume is decreased by turning the volume counter-clockwise.

### **5. Mode Setting Switch**

SW1 : Set to On position.

4-Tone chime is output when Talk button is pressed.

SW2 : Set to On position.

4-Tone chime is output when Talk button is turned to Off.

SW3 : Set to OFF position.

Voice broadcasting can be done using the MIC during the Talk button is pressed.

SW3 : Set the to ON position.

When the Talk button is once pressed, then voice broadcasting can be done.

Press the button once again to stop the Talk mode.

### **6. SERVICE TERMINAL**

This terminal is used only for service purposes.

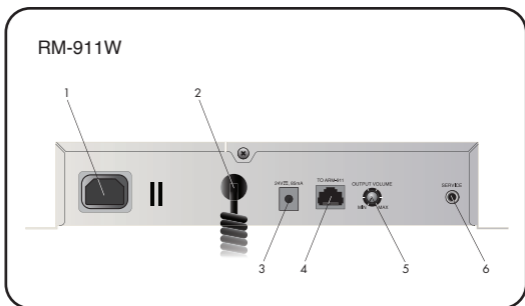

### 1. AC INPUT OF ADAPTOR (OPTION)

Install the external adaptor (OPTION) after open the left top cover, when it is needed.

The power is supplied by the ARM-911 if the adaptor is not used.

If the external adaptor is used, then the maximum operable distance can be extended and the power consumption of ARM-911 is decreased.

### 2. MIC INPUT TERMINAL

This is the terminal for the PTT MIC input.

### 3. EXTERNAL ADAPTOR (OPTION) INPUT

This is the DC 24V input terminal of the external adaptor.

NOTE: ADAPTOR (OPTION) can be installed inside the unit after open the left top cover or can be installed outside the unit and connect the DC 24V of the adaptor to the external adaptor input terminal.

If the adaptor is installed inside the unit, then install the adaptor after remove the metal plate of the AC input position of the adaptor.

Remove the metal plate.

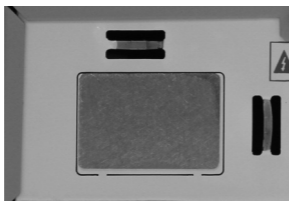

Open the left top cover. Screw off the bracket to fix adaptor.

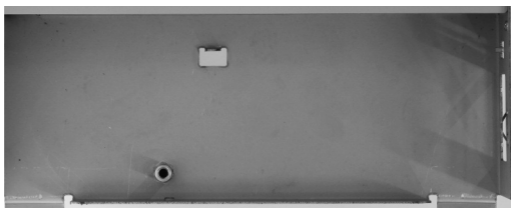

DC 24V  
Input Jack

Install the adaptor inside the unit.  
Connect the DC 24V Jack.  
Fix the adaptor with the bracket.

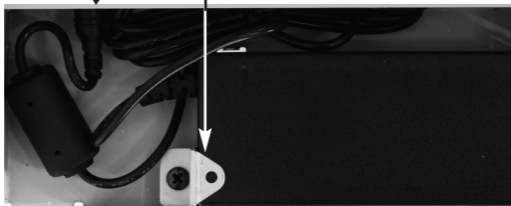

#### **4. CONNECTING TERMINAL OF ARM-911**

Connect to the ARM-911 using CAT5E cable.

The CAT5E pin description is as below.

Pin 1 : RS-422 RX+ (Refer to RM-911W)

Pin 2 : RS-422 RX- (Refer to RM-911W)

Pin 3 : RS-422 TX+ (Refer to RM-911W)

Pin 4 : DC24V

Pin 5 : GND

Pin 6 : RS-422 TX- (Refer to RM-911W)

Pin 7 : AUDIO HOT

Pin 8 : AUDIO COLD

#### **5. AUDIO OUTPUT VOLUME**

The audio output volume is increased by turning the volume clockwise.

The audio output volume is decreased by turning the volume counter-clockwise

#### **6. SERVICE TERMINAL**

This terminal is used only for service purposes.

## Operation Method

### ❑ SETTING PASSWORD

Connect to the ARM-911 network using the IP address of the ARM-911. Move to the RM password menu among the Administrator Menu. Input the password for the RM1, RM2, RM3, and RM4 respectively. Select SET button.

To use password, select the  use box. To not use the password, do not select the  use box.

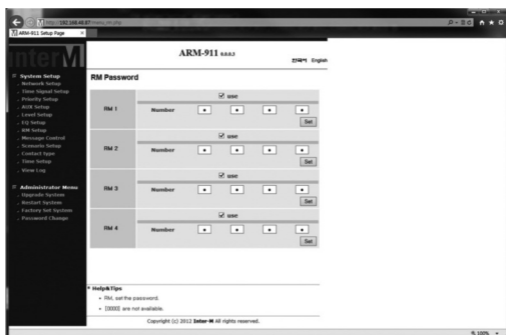

### ❑ INSTANT PLAY AT RM-911D/W

Press the password and then press the button to play the message. The LED of the button is lit and the message is played. If password is not correct or not inputted, then the IN-USE LEDs are blinking and the button does not lit and does not play the message.

If ARM-911 or RM-911D/W plays the one of 10 messages, then the corresponded button is lit. If the button which is lit is pressed in the one of 4 Remote Microphone



(RM-911D/W), then the broadcasting is stopped and the LED of the button is off.

If the password is inputted not correctly, then wait until the LED is off and input the password correctly.

#### □ **MODE SETTING SWITCH (RM-911D only)**



← Default

← ON Position

SW1 : Set to On position.

4-Tone chime is output when Talk button is pressed.

SW2 : Set to On position.

4-Tone chime is output when Talk button is turned to Off.

SW3 : Set to OFF position.

Voice broadcasting can be done using the MIC during the Talk button is pressed.

Set the SW3 to ON position.

When the Talk button is once pressed, then voice broadcasting can be done.

Press the button once again to stop the Talk mode.

# Connections

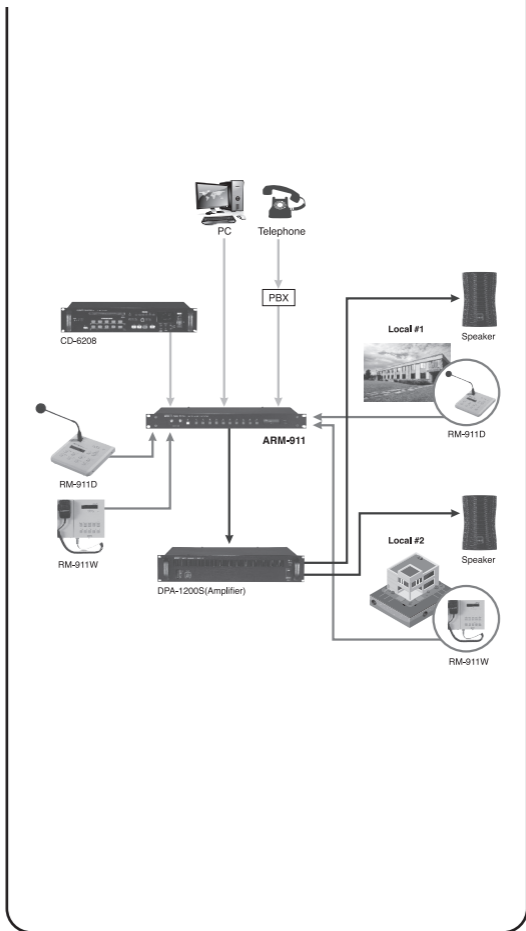

# Block Diagram

RM-911D

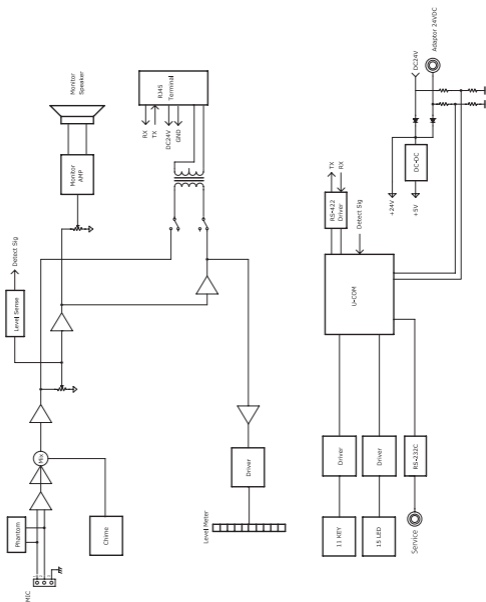

# RM-911W

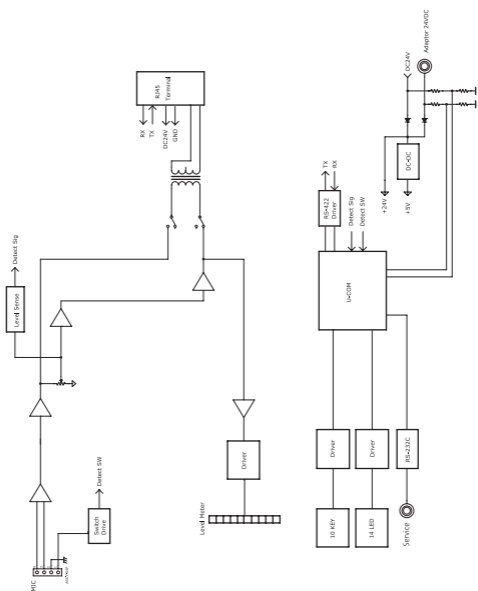

## Specifications

	<b>RM-911D</b>	<b>RM-911W</b>
MIC INPUT (1kHz)	Balanced	Unbalanced
Input Sensitivity	-50dBu $\pm$ 3dB	
Signal to Noise Ratio (S/N, 20kHz LPF, A-WTD)	NOR: 65dB LIM: 60dB	NOR: 63dB LIM: 58dB
Total Harmonic Distortion (THD, 20kHz LPF)	NOR: 0.3%, LIM: 0.7%	
Frequency Response (+1/-3dB)	150Hz - 18kHz	
Monitor Amp	0.5W 16 $\Omega$	-
Maximum Operable Distance CAT5E (50°C)	Cable resistance $\leq$ 30 $\Omega$ : 300m 30 $\Omega$ < Cable resistance $\leq$ 80 $\Omega$ : 100m	
Power Source	24VDC (From ARM-911)	
Power Consumption (From ARM-911 DC 24V)	4.8W	2W
Weight (SET)	1.37kg	1.7kg
Dimensions (SET)	200(W)x67(H)x206(D)mm 3.9(W)x2.6(H)x8.1(D)in	261(W)x188(H)x46(D)mm 10.3(W)x7.4(H)x1.8(D)in

\* Specifications and design subject to change without notice.

## Dimension

RM-911D

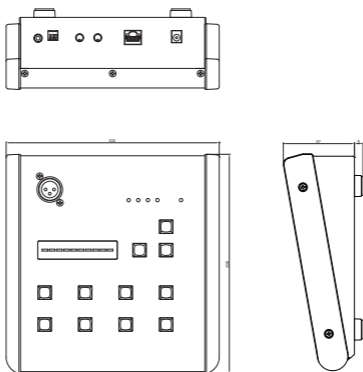

RM-911W

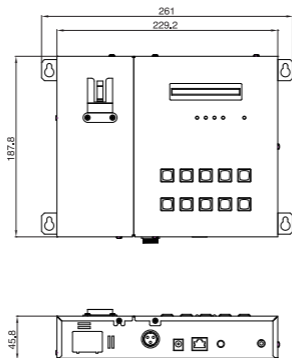

## Service

### Procedures

Ensure the problem is not related to operator error, or system devices that are external to this unit. Information provided in the troubleshooting portion of this manual may help with this process. Once it is certain that the problem is related to the product contact your warranty provider as described in the warranty section of this manual.

### Schematic

A Schematic is available by contacting your warranty provider.

### Parts List

A Parts List is available by contacting your warranty provider.

## Variations and Options

### Variations

Products supplied through legitimate sources are compatible with local AC power requirements.

### Options

No optional items are available for this product.

## Warranty

Warranty terms and conditions vary by country and may not be the same for all products. Terms and conditions of warranty for a given product may be determined first by locating the appropriate country which the product was purchased in, then by locating the product type.

To obtain specific warranty information and available service locations contact Inter-M directly(in Korea or the USA) or the authorized Inter-M Distributor for your specific country or region.

# interM



Inter-M, Ltd. (Korea) began operations in 1983.

Since then, Inter-M has grown to become one of the largest manufacturers of professional audio and commercial sound electronics equipment in the world.

Inter-M has gained worldwide recognition for its own branded products, as well as private label manufacturing of electronics sold under other names (OEM).

The company is no longer just a Korean company, but rather a global company that is truly international in scope, with factories and offices in Korea and China, and sales and marketing operations located in Japan, Europe, and the U.S.A.

With more than 850 employees around the globe, Inter-M is well-poised for further growth and expansion.

#### **INTER-M AMERICAS, INC.**

13875 ARTESIA BLVD. CERRITOS, CA 90703 USA  
TEL : +1-562-921-0313, FAX : +1-562-921-0370  
Home Page : <http://www.inter-m.net>, E-mail : [info@inter-m.net](mailto:info@inter-m.net)

#### **INTER-M Corporation**

SEOUL OFFICE: 653-5 BANGHAK-DONG, DOBONG-GU, SEOUL, KOREA  
TEL : +82-2-2289-8140~8, FAX : +82-2-2289-8149  
Home Page : <http://www.inter-m.com>, E-mail : [overseas@inter-m.com](mailto:overseas@inter-m.com)

**MADE IN KOREA**

[www.inter-m.com](http://www.inter-m.com)  
December 2013 133623