

Audio & Data Transmission Solution

FTA-108S FRA-108S

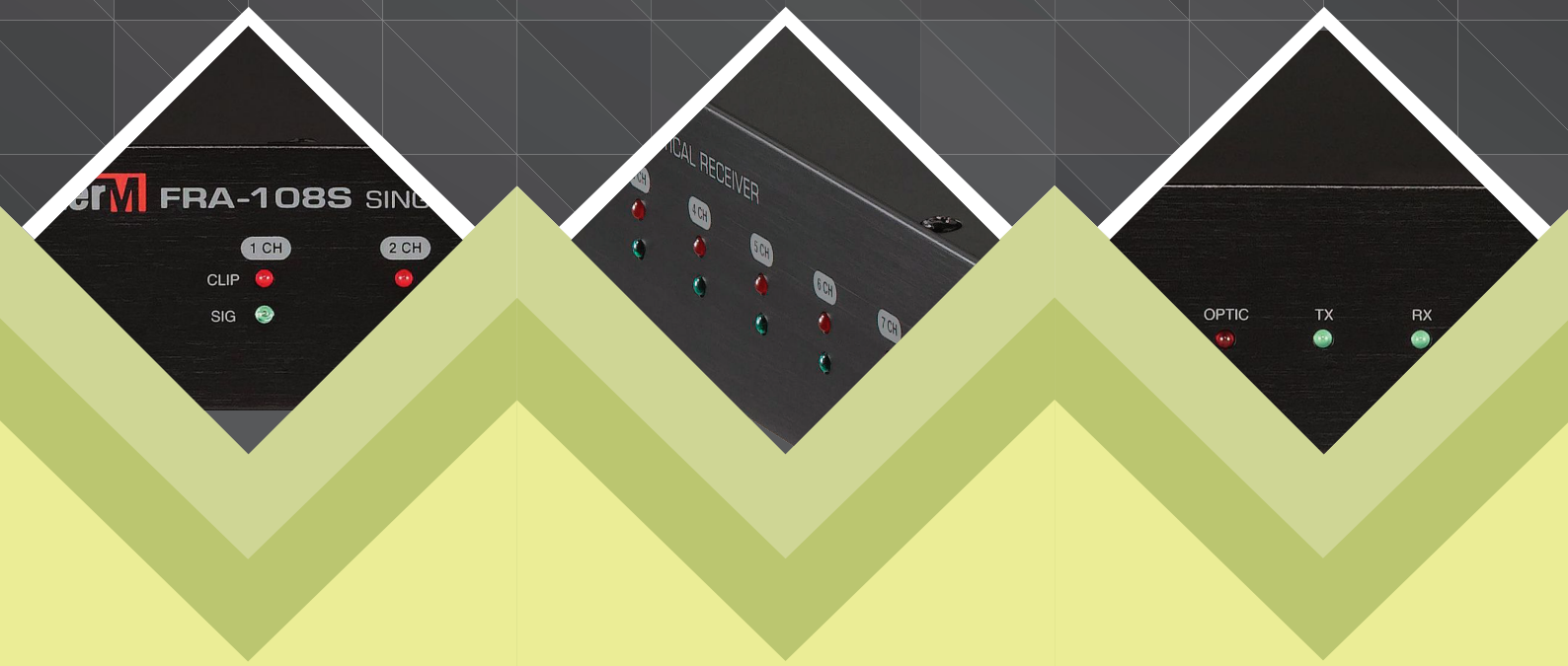

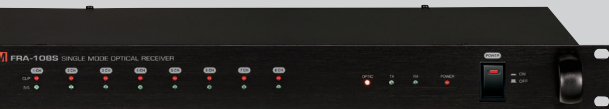

FTA/FRA-108S

Inter-M has developed solutions such as FTA/FRA-108S to transmit High quality uncompressed multi-channel audio and control over TCP/IP networks, dedicated copper lines and Optical fiber cables. FTA/FRA-108S will transport high quality 8-channel audio signals, serial data and contact closure triggers over long distances (up to 28 km) using Single-mode fiber-optic cable. These products will transport high quality uncompressed audio signals combined with data and contact triggers with very short and relatively small propagation delay of 1.0 msec.

DATA SHEET

FTA/FRA-108S

| | |
|--------------------|----------------------------------------------------|
| Connection Type | Single Mode Optical Cable(SC) |
| Max. distance | 28 km |
| Audio Channel | 1 : 1 One way 8 channel |
| Sampling Frequency | 24 Bit, 48 kHz |
| Frequency response | 20 Hz~20 kHz |
| S/N | 90 dB |
| THD | Less than 0.01 % |
| Data Type | RS-232C, RS422(CT/CR-100M) RS-485(CT/CR-600ECS) |
| Data Speed | maximum 19,200 bps |
| Channel | 8 Channel |
| optional | data/contact closure module |

FEATURES

High-quality audio data transmission

- Audio + data, single cable transmission system
- Uncompressed digital audio transmission(24 bit, 48 kHz)
- High-quality audio, better than S/N 90 dB, THD 0.01 or less
- Up to 8 channels of audio transmission
- Data(422/232/8 contacts trigger)transfer
- Up to 19200 bps data communication
- Long distance signal transmission
- Optical long-distance signal transmission(SC mode)
- High-quality hybrid Power Supply

User-friendly Functionality

- PAD switch
- Signal clip level indicators
- Sending and receiving data, power LED
- Fiber-optic cable connection status indicator LED
- Compact 1U size
- Simultaneous AC & DC redundant power

Construction for the purpose of convenience features

- Euroblock connectors for Easy Audio Wiring
- Detachable handle
- Balanced Audio input
- Optional Plug-in Communications module(3 types)

transmission using single-mode cable

These long-distance audio and data transport devices which transmit 8 channel audio signal and data by 1 core fiber-optic cable allow for easy of design and construction of Long-Line PA systems at budget saving prices.

- Long-Line transmission using single-mode fiber-optic cable

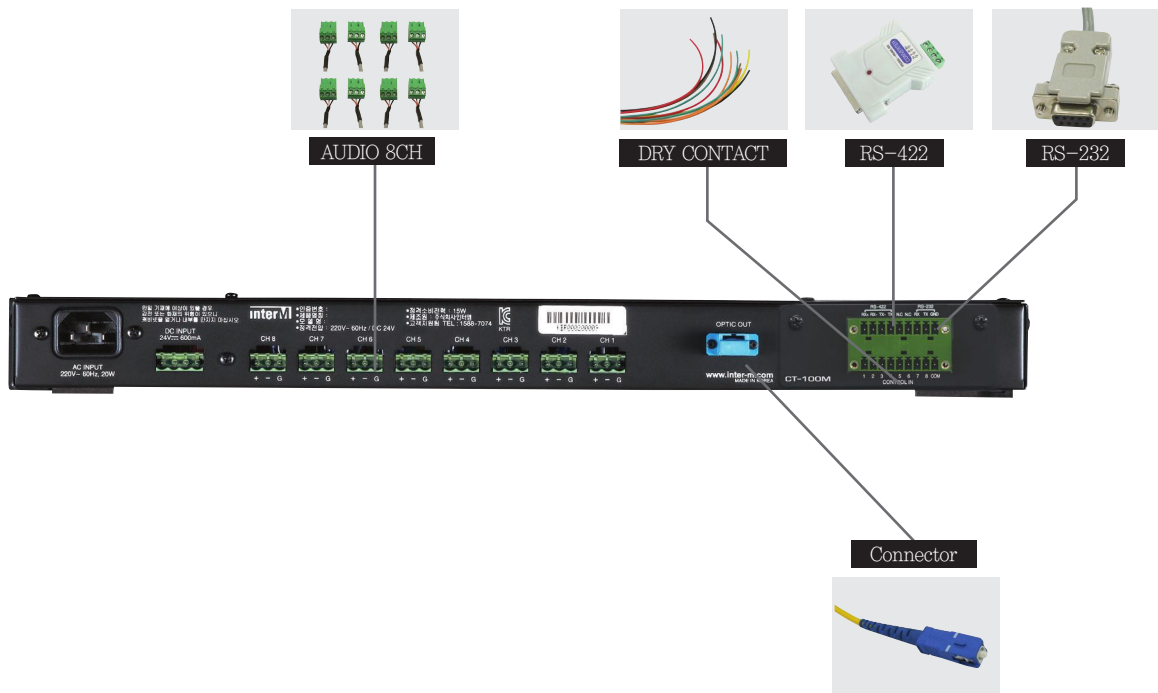

HiFi Audio Quality

It is long-distance digital transmission solution with balanced analogue audio signal without electromagnetic interference, signal loss or distortion, High quality uncompressed 24 bit digital audio at 48 kHz transmitted over TCP/IP network with a S/N better than 90 dB, THD less than 0,01.

- THD : Total harmonic distortion, The lower THD means that the equipment produces a more accurate reproduction by reducing harmonics added by electronics and audio media,
- S/N : Signal to Noise Ratio ,It is a measurement that compares the level of a desired signal to the level of background noise. It is defined as the ratio of signal power to the noise power, The higher the ratio indicates more signal than noise,

FEATURES

Data tunneling

Control of Local and remote equipment is possible using the built in eight programmable trigger inputs to initiate and terminate audio transmissions, eight programmable open control outputs as well as the RS-232 and RS-422 serial port or RS-485(Full Duplex methods) for data transmission/reception with communication speeds of up to 19200 bps.

CT-100M / CR-100M (Optional Module)

- Data transmission between equipments using by RS-232 and RS-422, Optional module for transmissions of trigger inputs
- Eight programmable trigger, RS-232C and RS-422 serial port for data transmission/reception (Euroblock type)
- Support equipment
 - CT-100M(Transmission) : FTA-108S
 - CR-100M(Reception) : FRA-108S

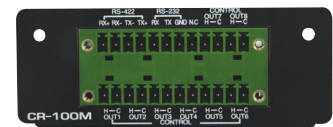
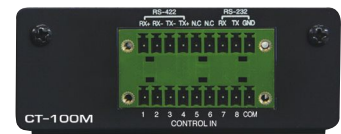

>> Option module half-detachable status

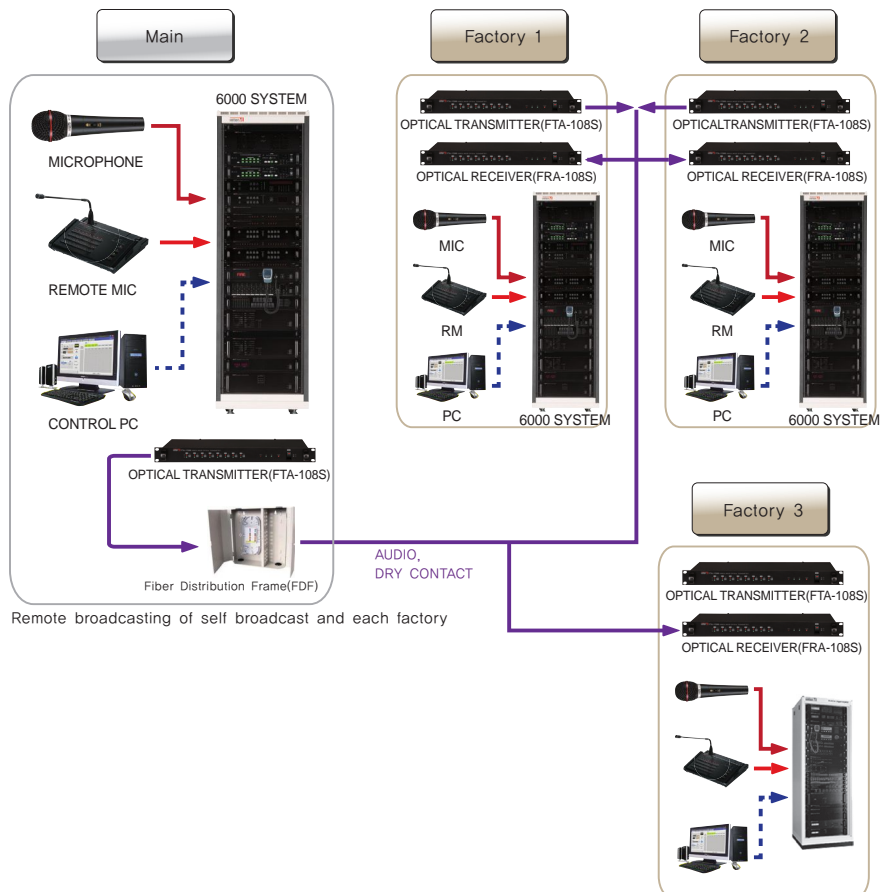

Each factory output a broadcast transmitted from self-broadcasting and main building

CT-600ECS / CR-600ECS (Optional Module)

- Optional Module for transmission/reception of communication signal (RS-485) for 6000 system (1bus, 8bus) and eight programmable trigger by FTA/FRA-108S
- Support equipment
 - CT-600ECS(Transmission) : FTA-108S
 - CR-600ECS(Reception) : FRA-108S

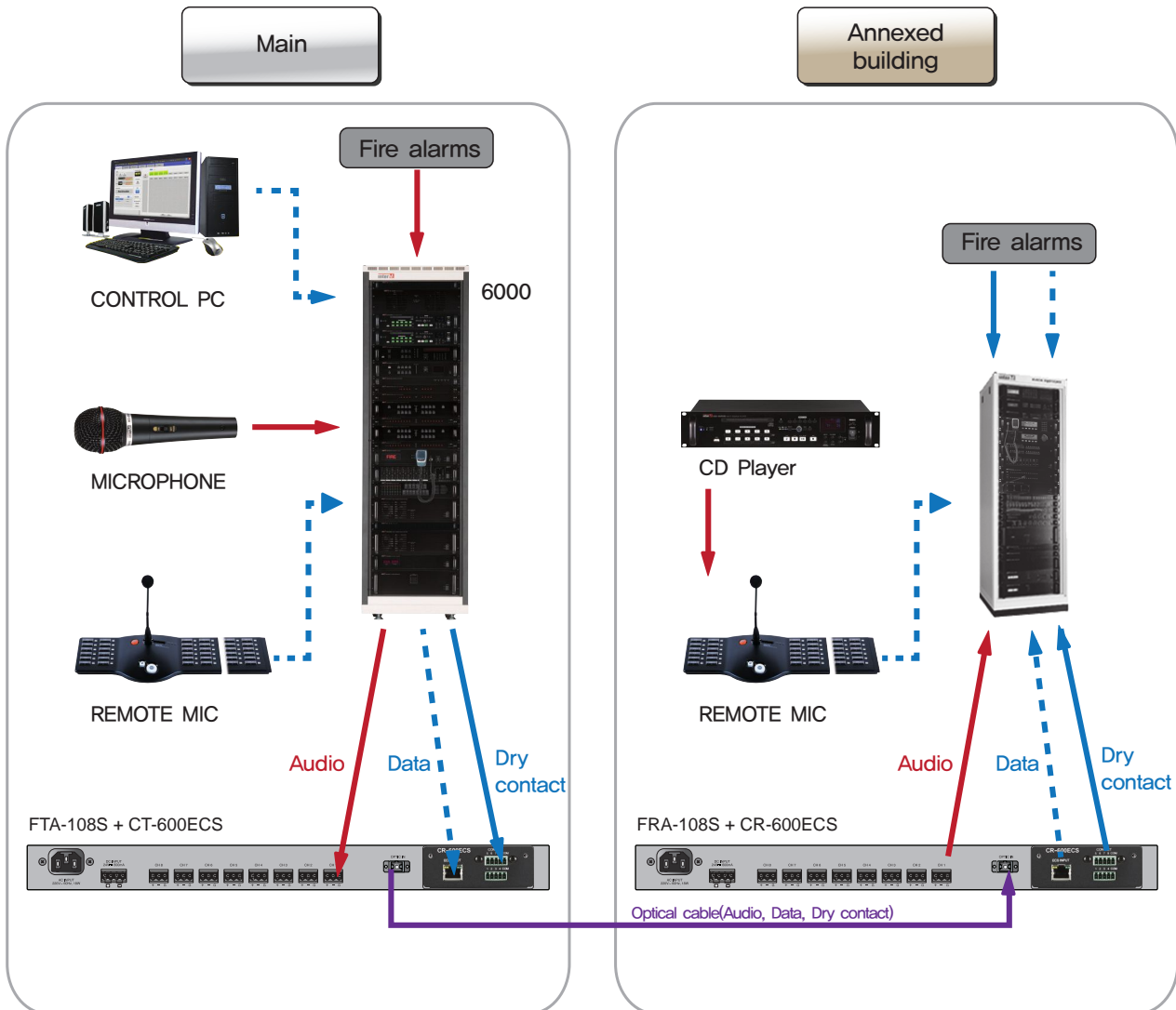
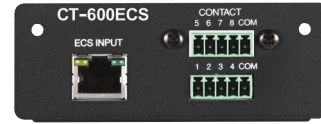

FEATURES

CT-600RM / CR-600RM (Optional Module)

- Optional Module for transmission/reception of Remote Mic (RM-6024) communication signal for 6000 system (1bus, 8bus) Audio signal and other trigger signal by FTA/FRA-108S
- Support equipment
 - CT-600RM(Transmission) : FTA-108S
 - CR-600RM(Reception) : FRA-108S

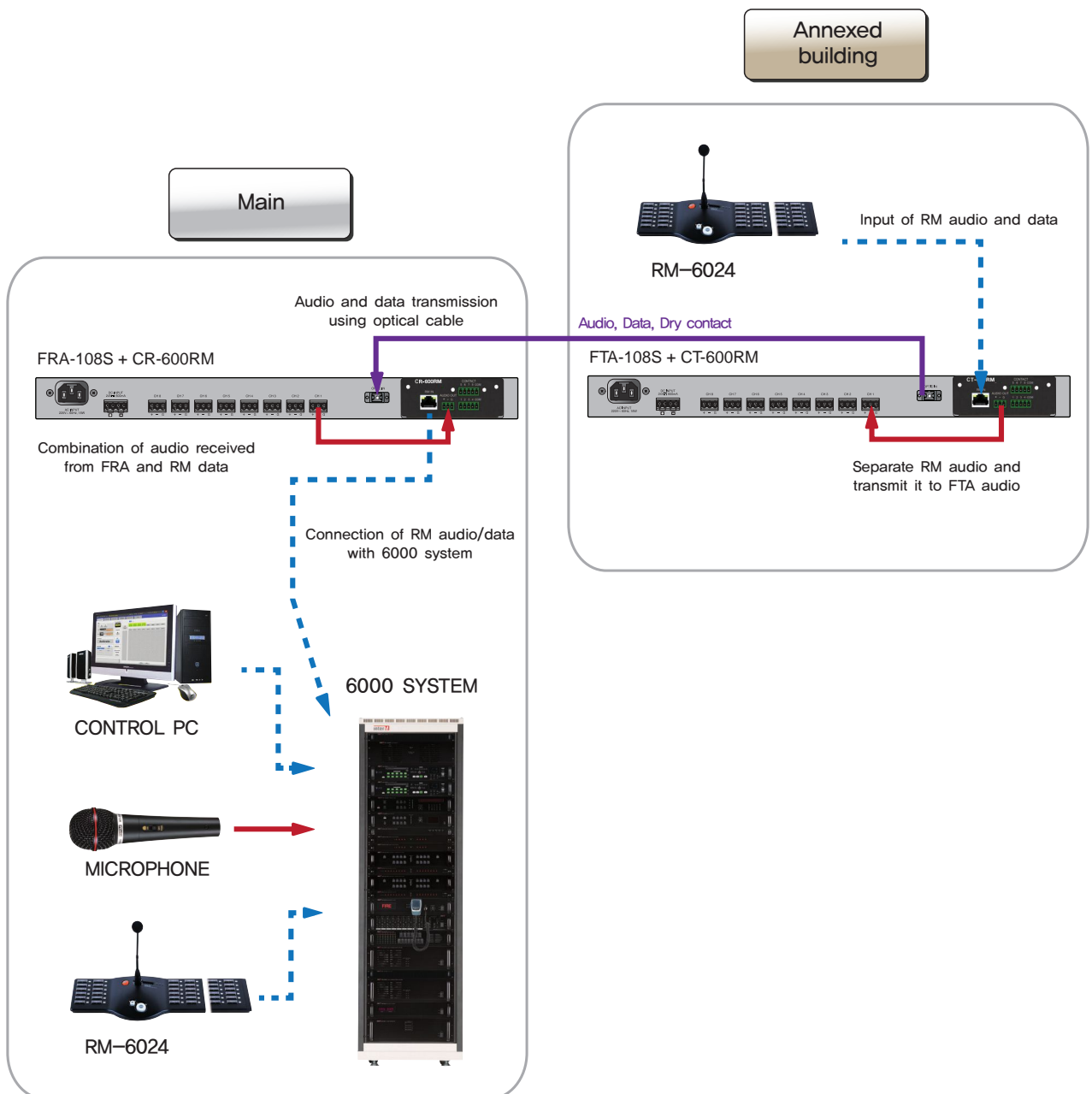

Long-Range

Inter-M's FTA/FRA-108S, long-distance audio, transmission products allows for high quality uncompressed audio including contact trigger and RS232 or RS422 data to be transported medium to long-distances and up to 28km using fiber optics cable.

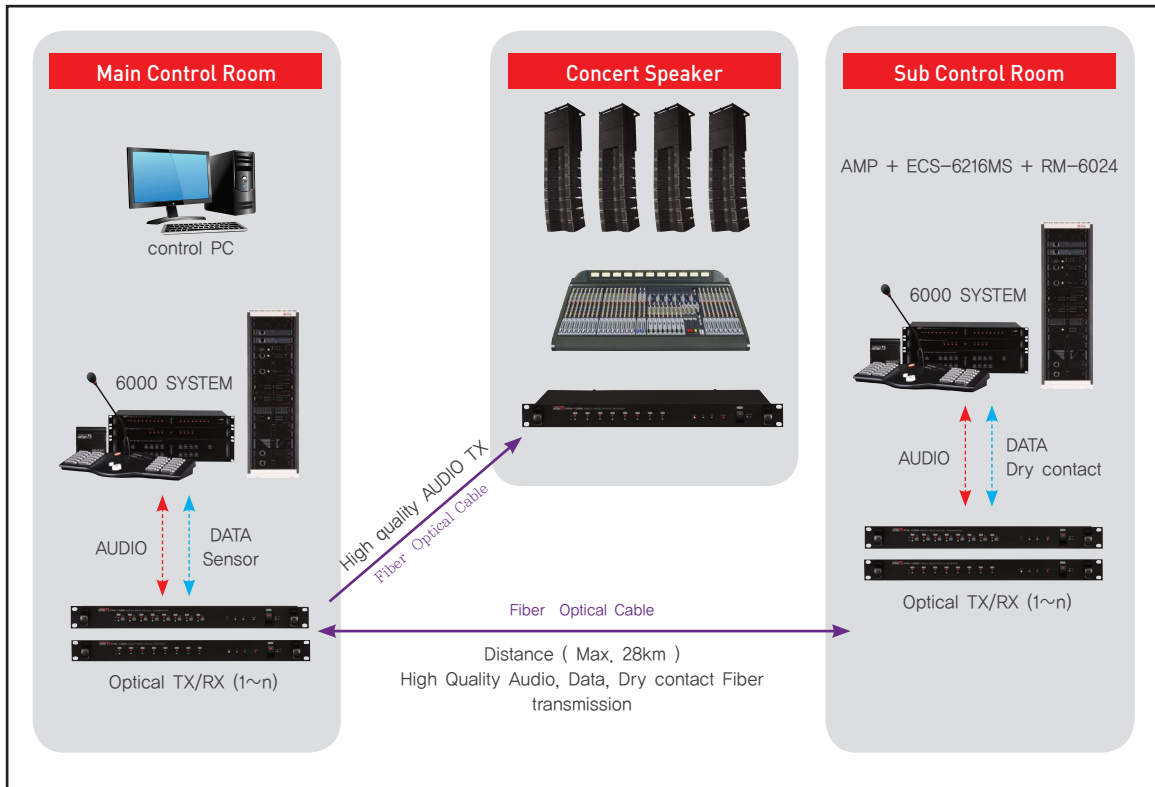

POWER

Simultaneous support of AC and DC power offering un-interrupted broadcast with emergency battery back up in the event of a power outage.

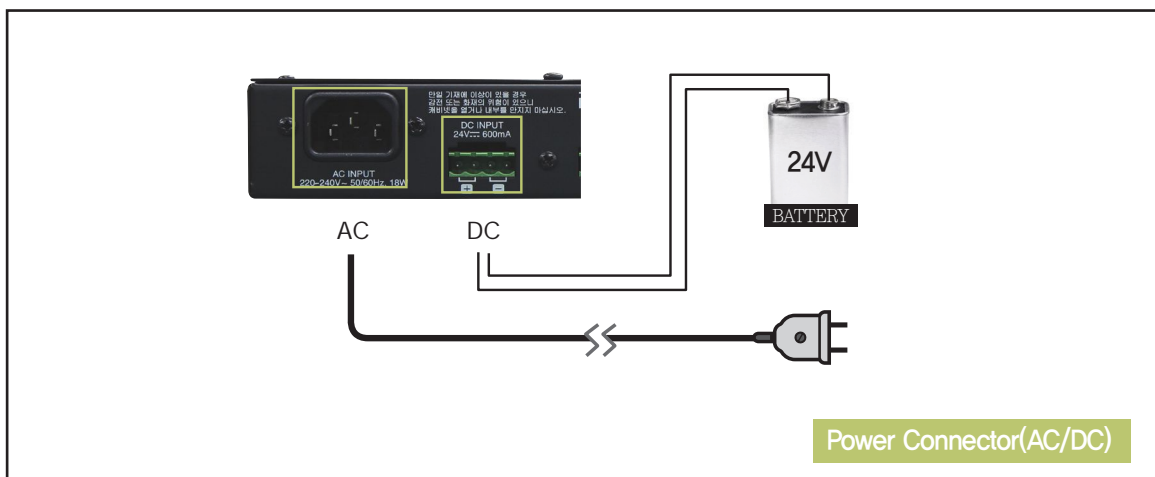

FEATURES

Simultaneous support of AC and DC power offering un-interrupted broadcast with emergency battery back up in the event of a power outage. Internal SMPS or Switch mode power supply offers maximum efficiency and economy.

Convenience

- A PAD switch allows for easy reduction of high signal levels.
- LED Audio signal clip indicators
- LED Data transmission, send and receive monitoring
- Fiber-optic cable connection status indicator LED.
- A built-in euroblock for the convenience of installation and the reduction of material cost

Front / Rear Panel



- | | |
|-----------------------------|-------------------------------------------|
| 1 Input Signal Display LED | 4 Cable Connection Status Display LED |
| 2 Output Signal Display LED | 5 Communication Module Status Display LED |
| 3 Pad Switch | 6 Power Switch |



- | | |
|------------------------|---------------------------------------------------|
| 1 AC Power | 4 Optical cable data connection terminal(SC Type) |
| 2 DC Power | – single mode Cable IC |
| 3 Audio input terminal | 5 Communication Module set(optional) |

Connection

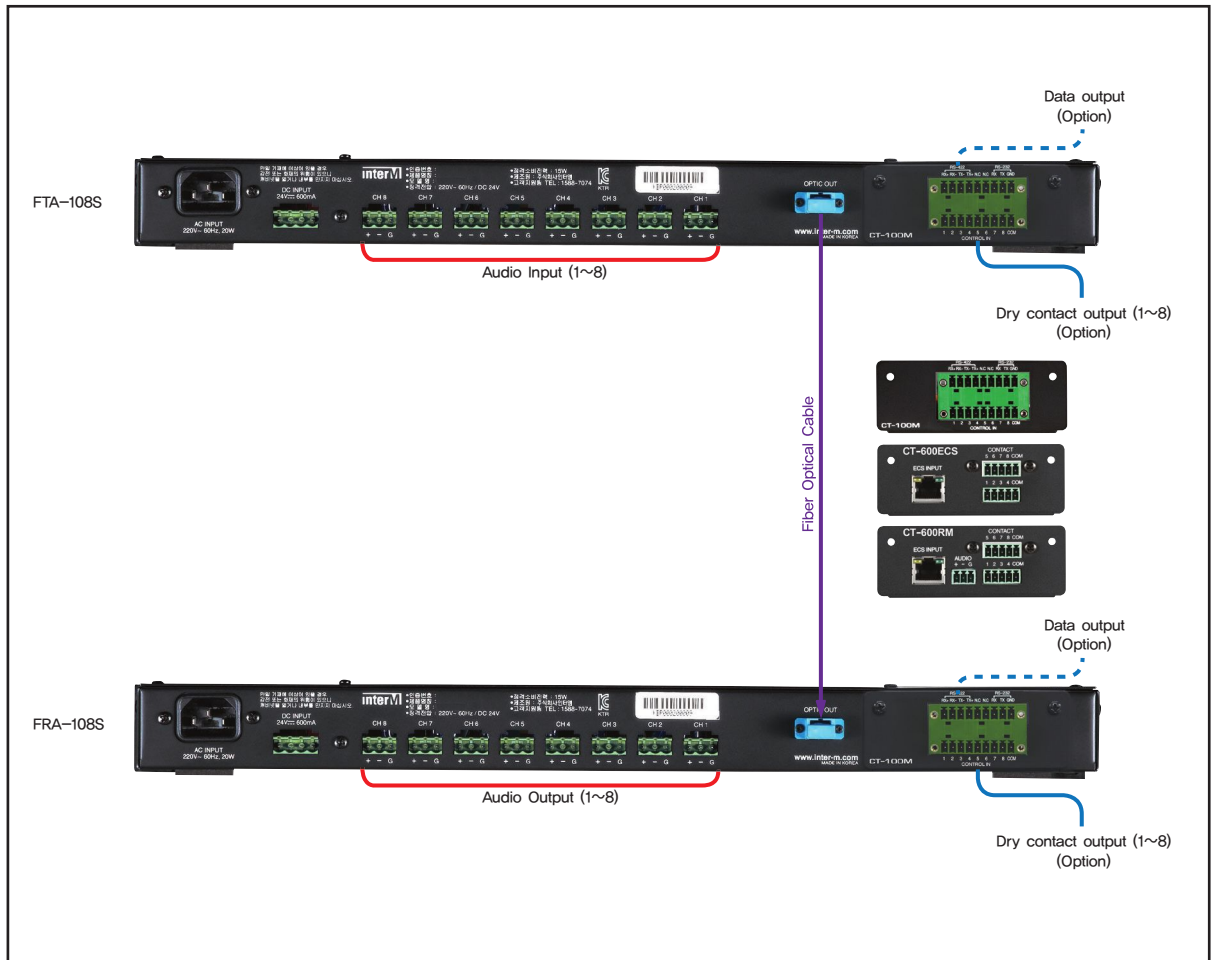

FTA/FRA-108S

Block diagram

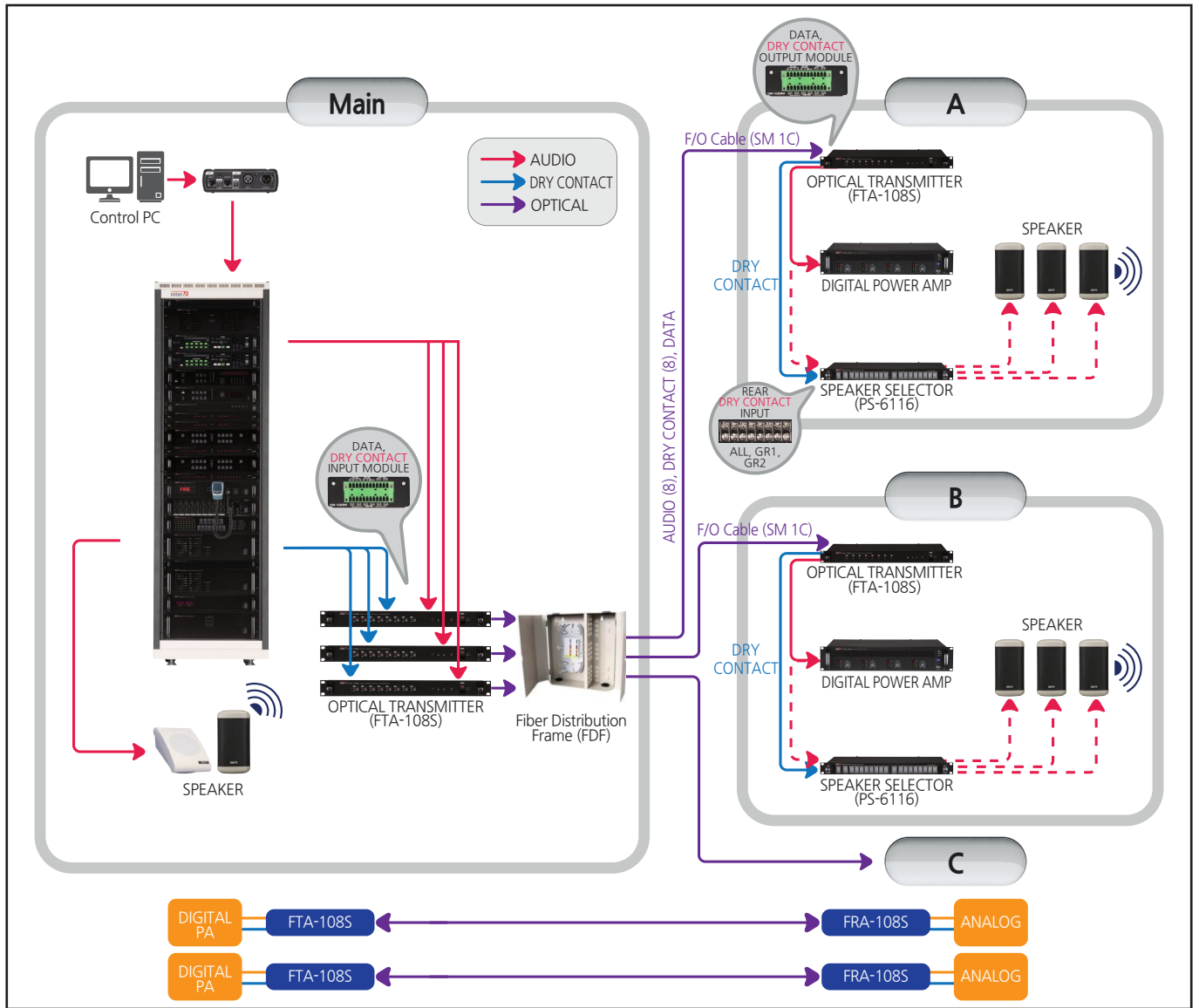

Digital System (Optical transmission)

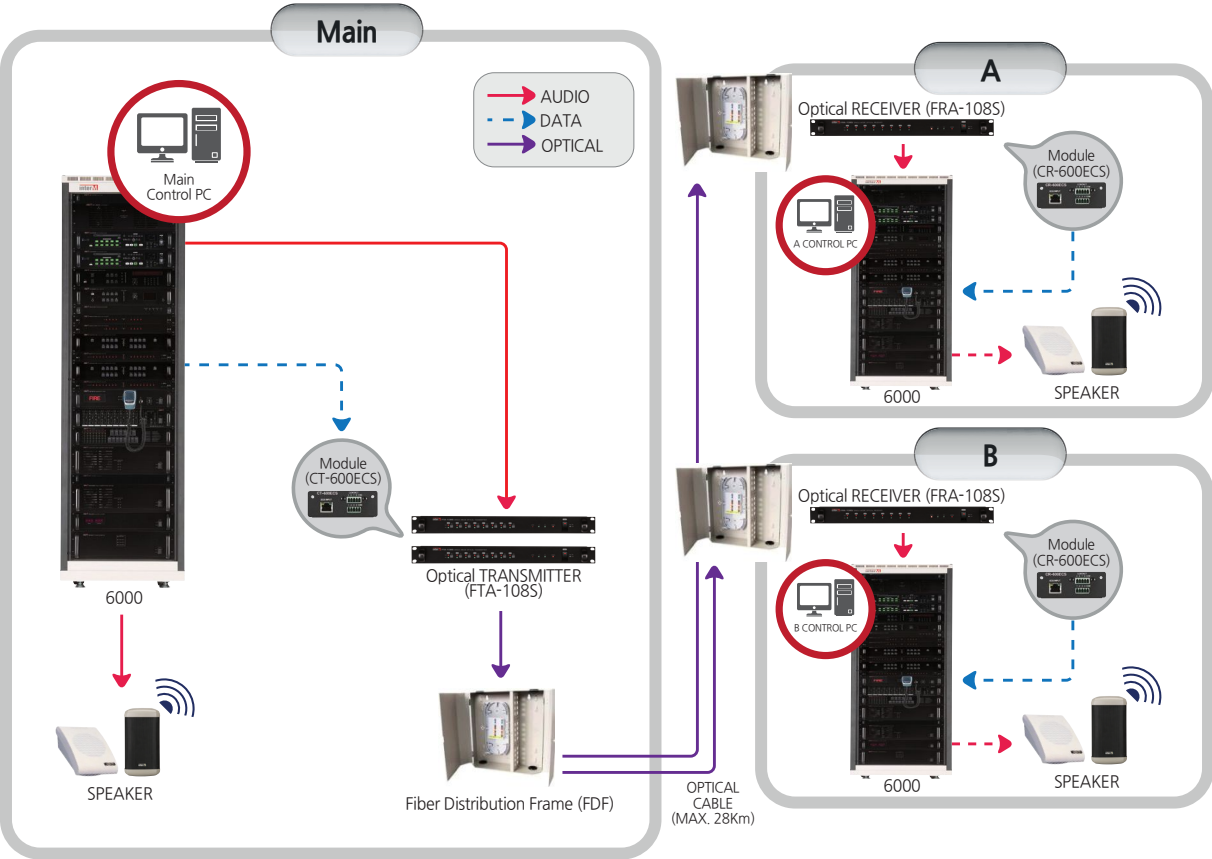
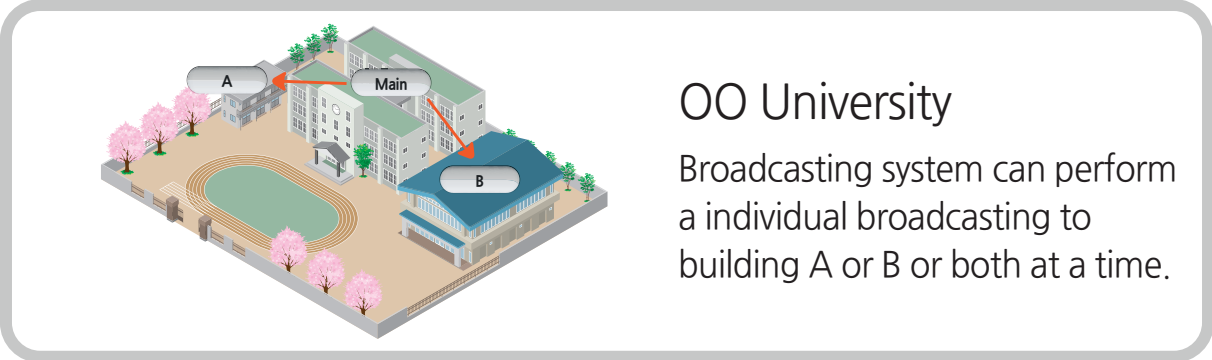

REMOTE MIC ▶ 6000 Digital System (Optical transmission)

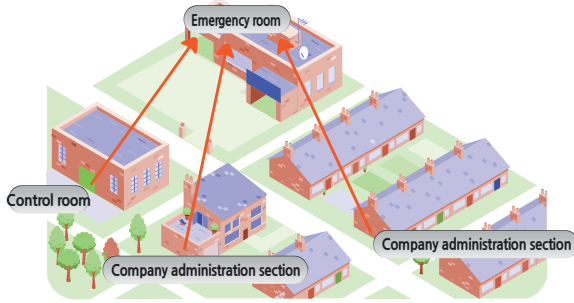

Military Facility

The system that can be broadcasted to Command & control center and each orderly room where are about 500 meters away from emergency room through remote microphone with optical cable.

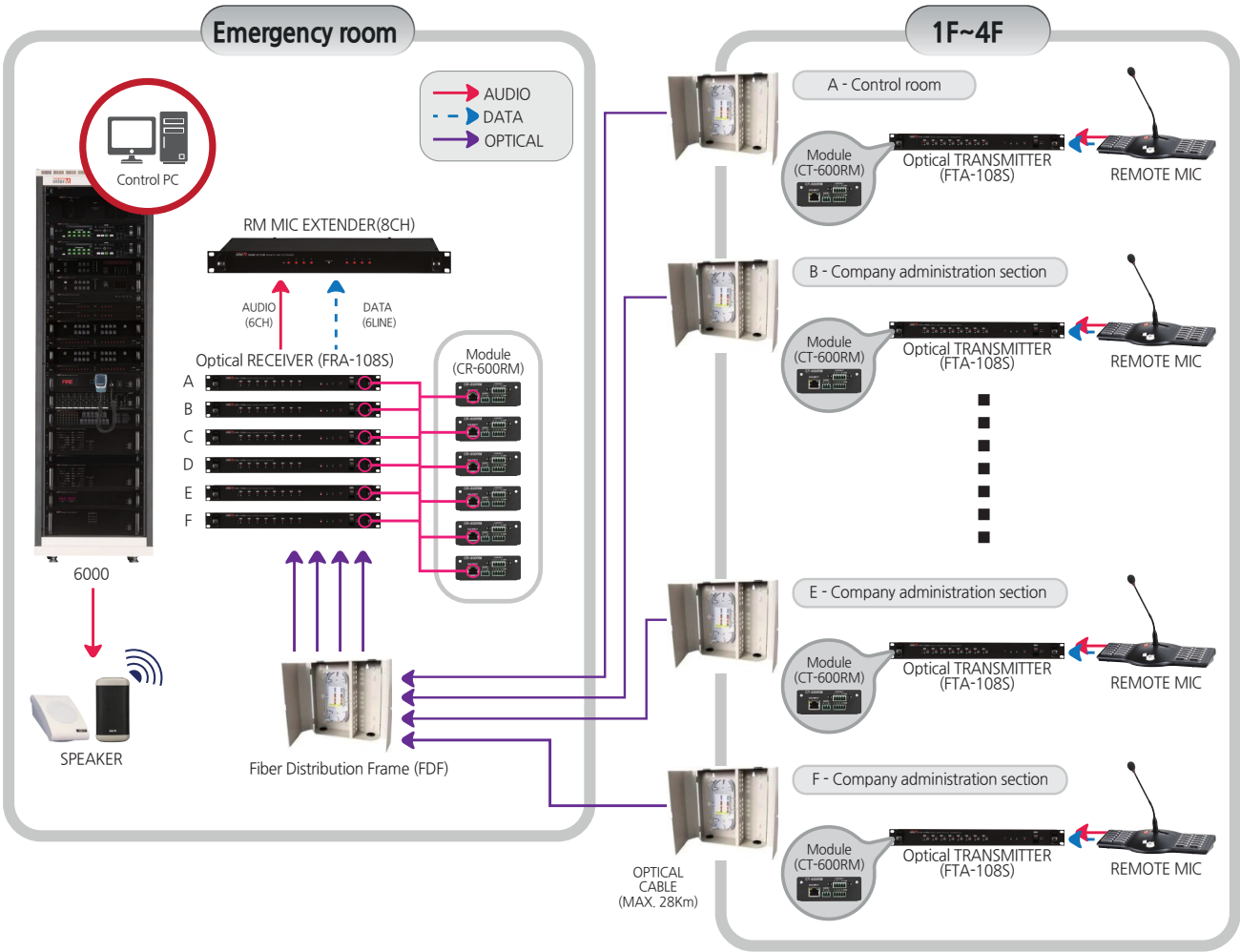

Digital system (optical transmission)

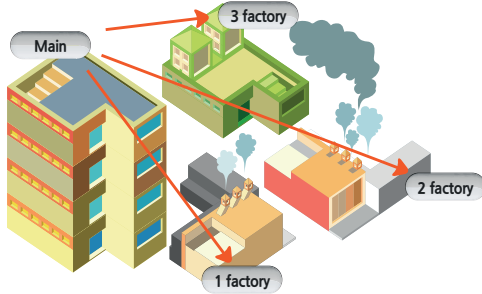

OO factory

The system which is possible to do all or individual broadcasting between main building and each factory and Interface broadcasting between Main office and each factories

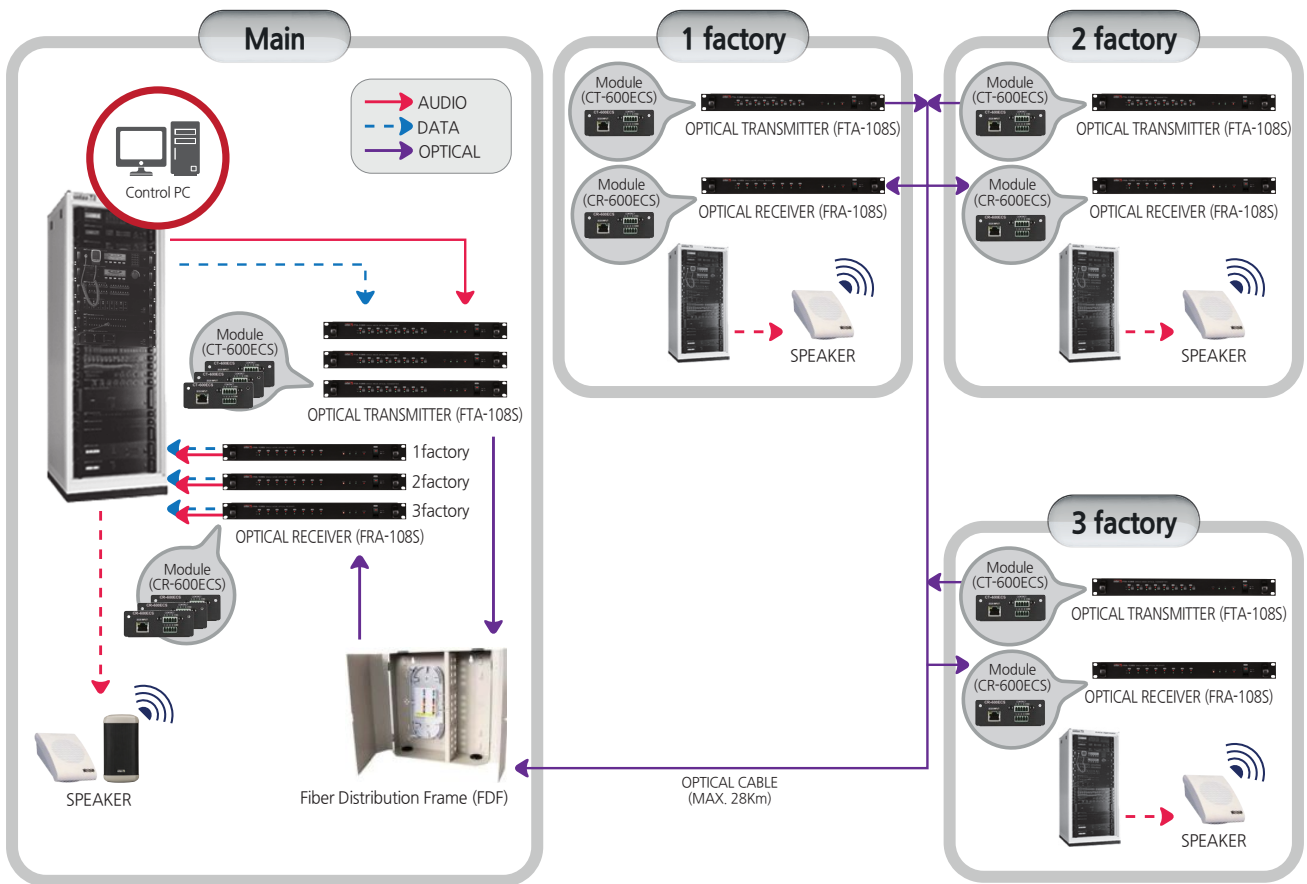

6000 ► Broadcasting system by other company (optical transmission)

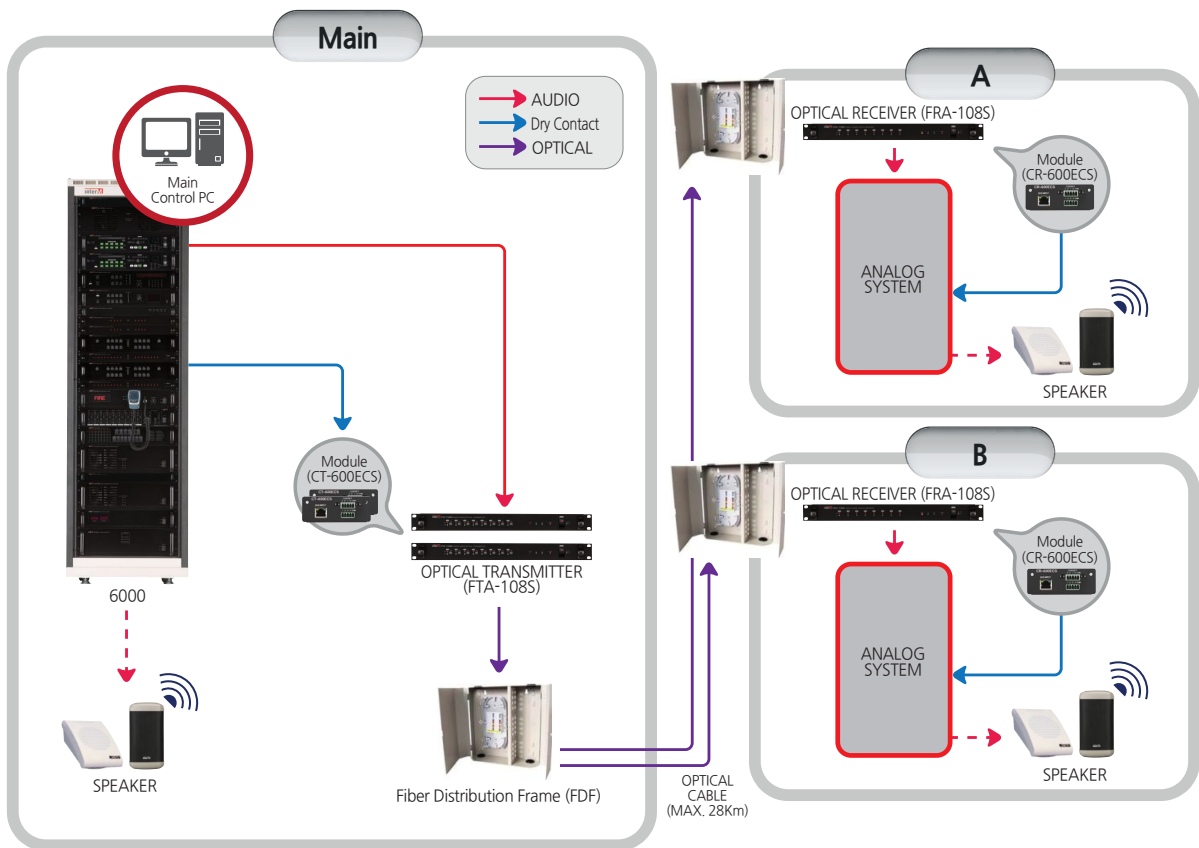
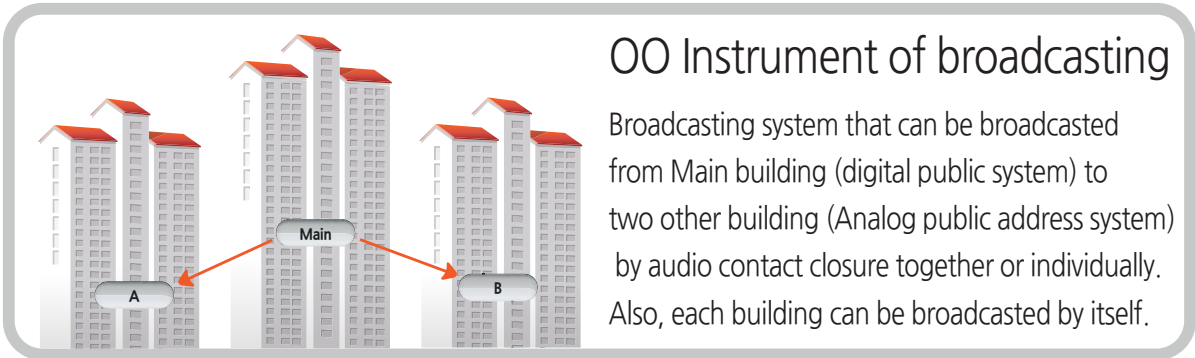

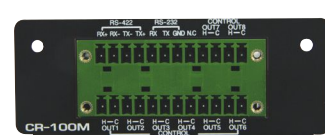
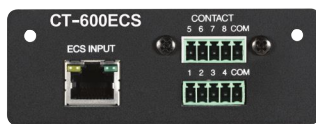
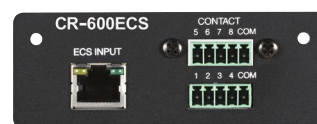
FTA-108S**FRA-108S****CT-100M****CR-100M****CT-600ECS****CR-600ECS****CT-600RM****CR-600RM****FTA-108S, FRA108S**

| | |
|-------------------------------|---------------------------------------------------|
| Input Sensitivity | 0 dBV/20 k Ω |
| THD(0 dBV Output, 20 kHz LPF) | Less than 0.01 % |
| Frequency Response | 20 Hz~20 kHz |
| Channel Separation | -90 dB over |
| Data Rate | 24 Bit, 48 kHz Sampling |
| Operating temperature | -10 °C~40 °C |
| Power source | 100-120 V AC or 220-240 V AC, 50/60 Hz or DC 24 V |
| Power consumption | AC : 18 W, DC : 24 V, 0.5 A |
| Weight(set) | 4.2 kg/9.3 lbs |
| Dimension | 482(W)×44(H)×280(D) mm/19(W)×1.7(H)×11(D) in |

Inter-M Corp. (IMK)

719, Dobong-ro, Dobong-gu, Seoul, Korea
Overseas Sales Team

Tel_ +82-2-2289-8141~7 Fax_ +82-2-2289-8149 E-mail_ overseas@inter-m.com

www.inter-m.com

※ Design and specification are subject to be changed for the improvement of product quality without pre notice.

2015. 10. V6