

# COLUMN SPEAKER

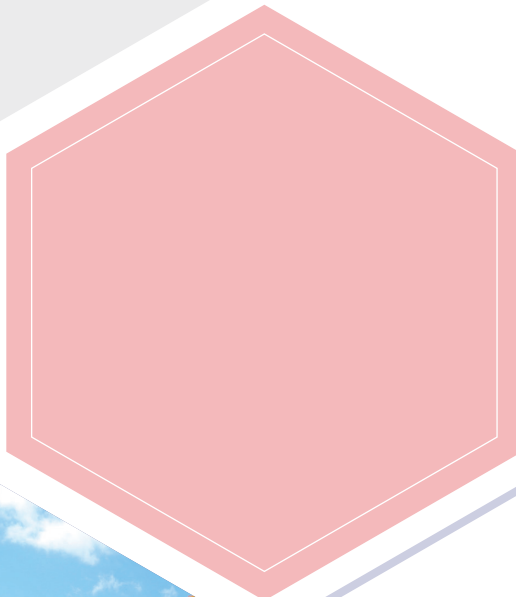

CU-20 Series



CU-7000 Series



CU-20 Series  
CU-40 Series  
CU-7000 Series  
CU-9000 Series



CU-40 Series



CU-9000 Series



COLUMN  
SPEAKER

## CU-20 SERIES

CU-21F/22F/24F, CU-21FO/22FO/24FO



## CU-40 SERIES

CU-41F/42F/44F, CU-41FO/42FO/44FO



## CU-7000 SERIES

CU-7060/7120

## CU-9000 SERIES

CU-9030/9060/9120



Column speaker is for public address and can be used for the purposes of announcement for delivering mainly messages and notifications of emergency broadcasting for safe evacuation in the event of disaster, and BGM broadcasting for creating natural atmosphere and image. You can select 100V/70V, 100/50 output for Inter-M column speaker and it can respond to various use environment by providing indoor speaker and outdoor speaker applied waterproof and dustproof design. Inter-M continuously provides multiple speaker line-ups with high reliability, high durability, and high quality.

## CU-20 SERIES



CU-20 series models are column speakers achieving the reasonable price while maintaining the performance for announcement and emergency broadcasting. They are speakers with solid designs using simple and clean aluminum bodies. They also provide indoor and outdoor types in order to use them at various places such as **shopping mall, school, parking lot, hotel, convention center, station, and airport.**

## CU-40 SERIES



CU-40 series models are standard column speakers achieving broad frequency band in order to be used for multi-purposes like emergency broadcasting, general broadcasting, and BGM broadcasting. They have a solid design through aluminum body and steel grill and provide wall mounting knuckles and U-brackets. They also provide indoor and outdoor types in order to use them at various places such as **station, airport, shopping mall, theme park, and parking lot.**

## CU-7000 SERIES



The CU-7000 series is an indoor column speaker specialized for places where rich sound pressure and high quality music reproduction are required. Designed to minimize driver-to-driver interference, it delivers clear and rich sound with high-frequency and low-loss professional-quality audio. It is suitable for indoor space such as **churches, religious facilities, hotel lobby, restaurant, etc.**

## CU-9000 SERIES



The CU-9000 series is a high-performance column speaker specialized in demanding environments. It is equipped with a high-performance speaker driver that enables clear voice transmission from a distance, and is designed to be durable with a waterproof and dust-proof design (IP65), an aluminium body and a galvanized steel grille. Therefore, it can be applied to **special facilities such as brine, port facilities that need to cope with corrosion, and factories that require dust prevention.**

## Quality Control – Provision of Reliability

Inter-M ships only reliable products with strict quality control through various tests such as 100-hour full power operation in a row, temperature (-10°C~40°C) and humidity(90~95%) to all of PA speakers including column speaker.

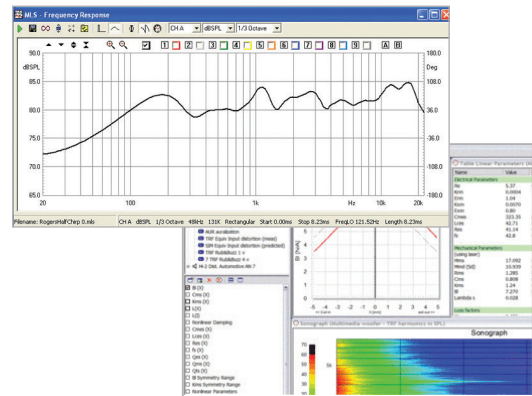

## Outdoor Type Speaker with Waterproof & Moistureproof Features

Outdoor type column speaker of Inter-M is certified for waterproof & moistureproof so that it can provide optimal performance even in poor outdoor environment.

IP34 : CU-21/22/24F/FO, CU-41/42/44F/FO, IP65 : CU-9030/9060/9120

Even use at outside for long time, it prevents deformation and fault.

**1st Digit – SOLID (Degree of protection against solid objects)**

	<b>1</b> Protected against a solid object greater than 50mm, such as a hand.		<b>4</b> Protected against a solid object greater than 2mm, such as a thin strap.
	<b>2</b> Protected against a solid object greater than 12mm, such as a finger.		<b>5</b> Dust protected. Prevents ingress of dust sufficient to cause harm.
	<b>3</b> Protected against a solid object greater than 2.5mm, such as a wire.		<b>6</b> Dust tight. No ingress of dust.



**2nd Digit – LIQUID (Degree of protection against water)**

	<b>1</b> Protected against water drops.		<b>4</b> Protected against water splashing from any angle.		<b>7</b> Protected against the effects of temporary submersion in water. (30 minutes at 3 feet)
	<b>2</b> Protected against water drops at a 15 degree angle.		<b>5</b> Protected against water jets from any angle.		<b>8</b> Protected against the effects of permanent submersion in water. (Up to 13 feet)
	<b>3</b> Protected against water spray at 60 degree angle.		<b>6</b> Protected against powerful water jets and heavy seas.		

## Selection of Long Distance Transfer and Output

Inter-M column speaker is designed to transmit the sound without any loss even in broad area where having high-rise buildings and needing long distance transfer by applying high quality of matching transformer (high impedance, 100V line). In addition, it can correspond to various environments as it can select 100V/70V, 100/50 output.

# Recommended usage of Column speakers

Column speakers are used in a wide variety of applications such as Emergency/Announcement broadcasting, BGM in various facilities, etc. The column speaker has a wide horizontal directional angle, and vertical directional angle can be narrowed and concentrated without spreading extra sound energy above and below. In outdoor use such as parks and outdoor parking lot, it can transmit a sound farther and cover a wide area. Also, in facilities with large reverberations such as airports, stations, and underground parking lots, the sound can be delivered directly to people where they are located, ensuring good intelligibility.

Intelligibility is an important factor when conveying information including BGM with a voice. If the intelligibility is poor, it can lose the ability to transmit information and cause simple noise. The articulation of the voice, which is a combination of vowels and consonants, is determined by the listening level of consonants. The vowels that occupy most of the voice energy are concentrated in the frequency band below about 1-2kHz. In addition, consonants that influence intelligibility are concentrated in the frequency band over 2kHz, and the frequency ranges from 7 to 8kHz depending on the pronunciation. Since human hearing is the most sensitive in the 2kHz to 4kHz band, it requires more than 3kHz to 4kHz playback in the mid-range to deliver the voice with good intelligibility.

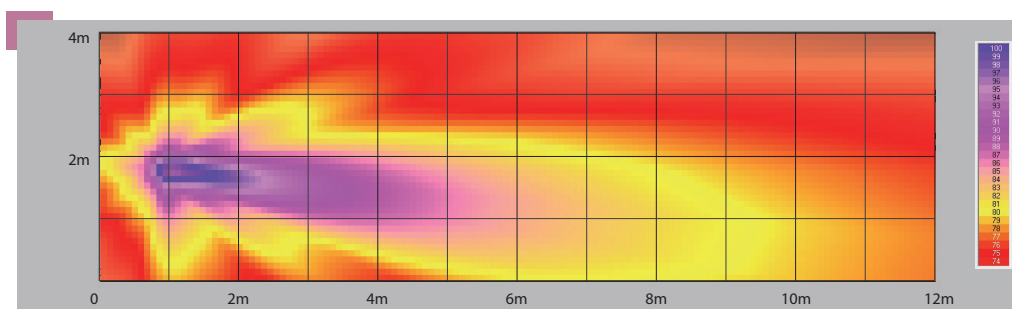

<Figure 1. Simulation with CU-44F viewed vertically (2kHz)> \* Scale: 1m interval

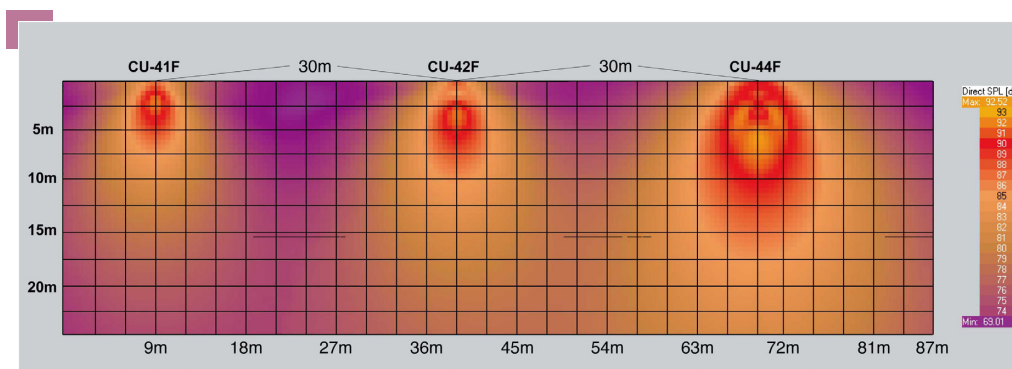

<Figure 2. CU-44F Horizontal simulation (2kHz)> \* Scale  
 Hight : 3m interval  
 Width : 2.5m interval

Viewed in horizontal and vertical directions, CU-44F is a simulation of 2kHz EASE sound pressure distribution, a standard column speaker that can support from announcement to BGM playback.

At the frequency of 2-4 kHz, which influences intelligibility, the horizontal has a wide spreading characteristic of 130 °, and the vertical is made narrower by about 30 °.

When used indoors, the energy reflection and reverberation on the ceiling is reduced, thus paging becomes more intelligible. Maintaining performance for announcement/emergency broadcasting, Inter-M's Column CU series is equipped with the CU-20 series of a more reasonable price, indoor CU-7000 series specialized for music playback, and the high-performance CU-9000 series specialized in demanding outdoor environments to be used for multipurpose for Guide/Emergency broadcasting and BGM, in addition to the CU-40 series, which is a column standard that realizes a wide frequency band.

\* Required sound pressure level according to noise

The following table is showing the noise level and the sound pressure level of each space.

It is clear when the broadcasting is delivered at a sound pressure with 6dB higher than the noise level where the space using, and optimal playback is possible which is not masked by noise

<Sound pressure standard table>

Space	Average noise level (dB)	Broadcast sound pressure level	
		BGM (Music)	Announcement
Train platform, parking lot	80 ~ 90	93	96
Factory, workspace	75 ~ 85	88	91
General store, waiting room	70 ~ 80	83	86
Hotel, office, etc	60 ~ 70	73	76

When installing a speaker, EASE simulation can visually express the speaker's cover range, sound pressure level, and articulation, including architectural sound. It is simulation software commonly used in the professional market because it allows an accurate simulation at the design level.

Series	Item	Model	Input Power	Max SPL	Weight	Dimension (mm)	IP	Page
20 Series	Indoor	CU-21F	10W/7.5W/ 5W/2.5W	97dB	1.8kg	135 x 280 x 109	-	P10
		CU-22F	20W/15W/ 10W/5W	103dB	3kg	135 x 280 x 109	-	
		CU-24F	40W/30W/ 20W/10W	107dB	4.65kg	135 x 280 x 109	-	
	Outdoor	CU-21FO	10W/7.5W/ 5W/2.5W	97dB	1.8kg	135 x 280 x 109	IP34	P11
		CU-22FO	20W/15W/ 10W/5W	103dB	3kg	135 x 280 x 109	IP34	
		CU-24FO	40W/30W/ 20W/10W	107dB	4.65kg	135 x 280 x 109	IP34	
40 Series	Indoor	CU-41F	10W/7.5W/ 5W/2.5W	98dB	1.95kg	156 x 300 x 129	-	P12
		CU-42F	20W/15W/ 10W/5W	103dB	3.15kg	156 x 400 x 129	-	
		CU-44F	40W/30W/ 20W/10W	108dB	4.75kg	156 x 600 x 129	-	
	Outdoor	CU-41FO	10W/7.5W/ 5W/2.5W	98dB	1.95kg	156 x 300 x 129	IP34	P13
		CU-42FO	20W/15W/ 10W/5W	103dB	3.15kg	156 x 400 x 129	IP34	
		CU-44FO	40W/30W/ 20W/10W	108dB	4.75kg	156 x 600 x 129	IP34	
7000 Series	Indoor	CU-7060	60W/30W	111dB	5.42kg	130 x 420 x 195	-	P14
		CU-7120	120W/60W	116dB	8.02kg	130 x 620 x 195	-	
9000 Series	Special	CU-9030	30W/15W	106dB	3.09kg	130 x 320 x 125	IP65	P15
		CU-9060	60W/30W	110dB	4.66kg	130 x 450 x 125	IP65	
		CU-9120	120W/60W	112dB	7.05kg	130 x 650 x 125	IP65	



# Speaker Guide by Use Place

☆ : BEST, ○ : GOOD

Item	For Indoor Use			For Outdoor Use		Special Use	
	Series	CU 20F	CU 40F	CU 7000	CU 20FO	CU 40FO	CU 9000
Education Facilities	School	○	☆		○	☆	○
	University	○	☆	○	○	☆	○
	Training Institute	○	☆	○	○	☆	○
Cultural Facilities	Exhibition Hall	○	☆		○	☆	
	Religious Facility		○	☆	○	☆	
	Theme Park		☆	○		○	☆
Commercial Facilities	Shopping Center	○	☆	○	○	☆	
	Restaurant		○	☆	○	☆	
	Cafe		○	☆	○	☆	
	Department Store		○	☆	○	☆	
	Government Office	○	☆	○		○	☆
	Factory	○	☆			○	☆
	Airport		☆	○		○	☆
	Station	○	☆			○	☆
	Hospital	○	☆	○		○	☆
Sports Facilities	Gym	○	☆		○	☆	
	Stadium	○	☆			○	☆
	Park				○	○	☆
Other Facilities	Apartment	○	☆		○	☆	
	High-Rise Residential Building	○	☆	○	○	☆	
	Military Facility	○	☆			○	☆
	Port Facility	○	☆			○	☆
	Parking Lot	○	☆			○	☆

1. Decide the use place first and then select if it is for indoor or outdoor.
2. CU-20 series are entry-level indoor/outdoor products and CU-40 series are standard-level indoor/outdoor products  
CU-7000 series are exclusive indoor product for BGM and CU-9000 series are exclusive outdoor product corresponding to EN54.
3. For more details, you can check at the right page and move to the page.

# CU-21F/22F/24F

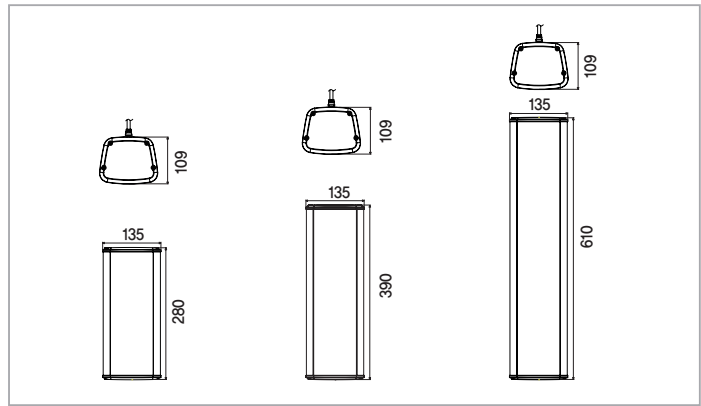

- ◆ Use 4" full-range of driver having excellent sound quality/articulation/durability
- ◆ Indoor type, 100V/70V line of high impedance model
- ◆ Use solid aluminum body and flame retarding grill
- ◆ Are installed harmoniously to interior architectural design using clean & simple design and silver color
- ◆ Providing 3 models to choose 10W / 20W / 40W power depending on the application
- ◆ Show the maximum feature of exclusive speaker unit with the use of high-performance matching transformer produced by Inter-M
- ◆ Easy input power selection through wiring
- ◆ Provide U-bracket which can be easily installed to street lamp and pole

## SPECIFICATION

Model	CU-21F		CU-22F		CU-24F	
Type	Single 4" Full-range Column Speaker		Dual 4" Full-range Column Speaker		Quad 4" Full-range Column Speaker	
Driver	4" x 1		4" x 2		4" x 4	
Power Handling (AES)	10W		20W		40W	
Input Power	100V	10/7.5/5/2.5W	20/15/10/5W		40/30/20/10W	
	70V	10/7.5/5/2.5W	20/15/10/5W		40/30/20/10W	
Impedance	100V	1k/1.3k/2k/4kΩ	500/660/1k/2kΩ		250/330/500/1kΩ	
	70V	500/660/1k/2kΩ	250/330/500/1kΩ		125/160/250/500Ω	
Power Selection	By Wiring					
Frequency Range(-10dB)	127Hz ~ 20kHz		137Hz ~ 20kHz		128Hz ~ 20kHz	
Frequency Range(-20%)	100Hz ~ 20kHz		108Hz ~ 20kHz		94Hz ~ 20kHz	
Sensitivity (1W/1m, 1kHz)	87dB		90dB		91dB	
Maximum SPL[Cont]	97dB		103dB		107dB	
Nominal Dispersion(HxV)	1kHz	205° x 154°	220° x 120°		208° x 60°	
	4kHz	122° x 141°	103° x 33°		106° x 16°	
Input Connection	Bi-Wired INPUT Line Direct Connection					
Enclosure Material	Body : AL/Top, Bottom : Composite PP(GP-3152F), INSERT NUT					
Enclosure Color	Body : Silver/Top, Bottom : Black					
Grille Material	EGI 0.8T		EGI 0.8T		EGI 0.8T	
Grille Color	SILVER		SILVER		SILVER	
Weight(Net)	1.8kg		3kg		4.65kg	
Dimensions(Net, WxHxD, mm)	135 x 280 x 109		135 x 390 x 109		135 x 610 x 109	
Flame Resistant	O		O		O	
Included Accessories	U Bracket					

## FREQUENCY RANGE

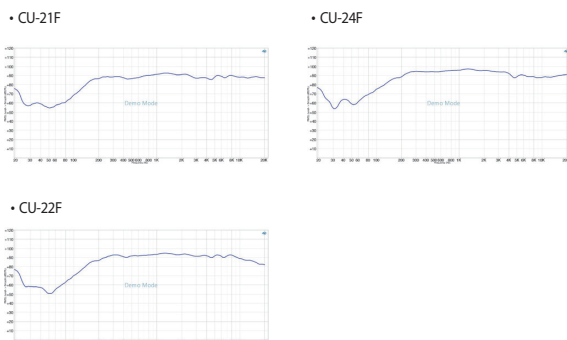

## POLAR PATTERN (1kHz/4kHz)

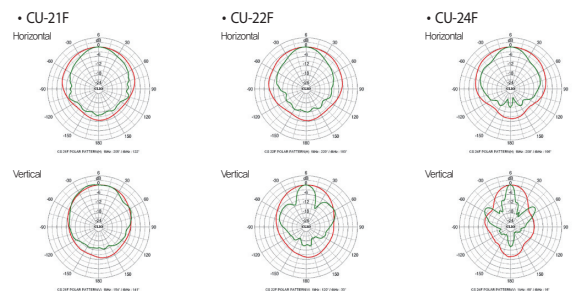

# CU-21FO/22FO/24FO

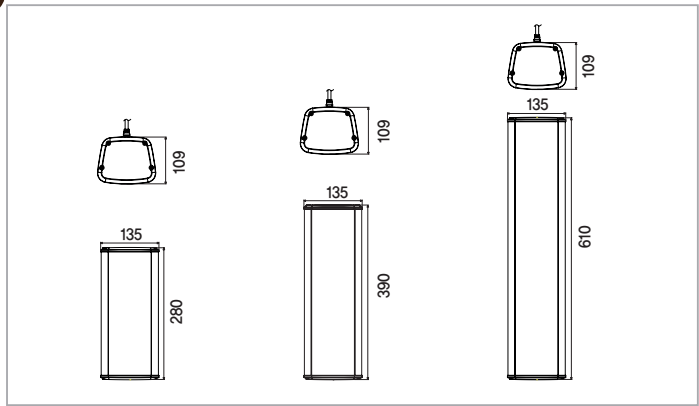

- ◆ Use 4" full-range of driver having excellent sound quality/articulation/durability
- ◆ Outdoor type, 100V/70V line of high impedance model
- ◆ Use solid aluminum body and flame retarding grill
- ◆ Use titanium color which does not damage the landscape of outdoor facility and prevents the discoloration even for long time use with clean & simple design
- ◆ Excellent waterproof, moistureproof, and dustproof (IP34)
- ◆ Providing 3 models to choose 10W / 20W / 40W power depending on the application
- ◆ Show the maximum feature of exclusive speaker unit with the use of high-performance matching transformer produced by Inter-M
- ◆ Easy input power selection through wiring
- ◆ Provide exclusive knuckle bracket which enables the angle adjustment 30 degree downward and each 90 degree toward right and left

## SPECIFICATION

Model	CU-21FO		CU-22FO		CU-24FO	
Type	Single 4" Full-range Column Speaker		Dual 4" Full-range Column Speaker		Quad 4" Full-range Column Speaker	
Driver	4" x 1		4" x 2		4" x 4	
Power Handling(AES)	10W		20W		40W	
Input Power	100V	10/7.5/5/2.5W	20/15/10/5W		40/30/20/10W	
	100V	10/7.5/5/2.5W	20/15/10/5W		40/30/20/10W	
Impedance	100V	1k/1.3k/2k/4kΩ	500/660/1k/2kΩ		250/330/500/1kΩ	
	100V	500/660/1k/2kΩ	250/330/500/1kΩ		125/160/250/500Ω	
Power Selection	By Wiring					
Frequency Range(-10dB)	127Hz ~ 20kHz		137Hz ~ 20kHz		128Hz ~ 20kHz	
Frequency Range(-20%)	100Hz ~ 20kHz		108Hz ~ 20kHz		94Hz ~ 20kHz	
Sensitivity(1W/1m, 1kHz)	87dB		90dB		91dB	
Maximum SPL[Cont]	97dB		103dB		107dB	
Nominal Dispersion(HxV)	1kHz	205° x 154°	220° x 120°		208° x 60°	
	4kHz	122° x 141°	103° x 33°		106° x 16°	
Input Connection	Bi-Wired INPUT Line Direct Connection					
Enclosure Material	Body : AL/Top, Bottom : Composite PP(GP-3152F), INSERT NUT					
Enclosure Color	Body : Light Brown/Top, Bottom : Black					
Grille Material	EGI 0.8T					
Grille Color	Light Brown					
Weight(Net)	1.8kg		3kg		4.65kg	
Dimensions(Net, WxHxD, mm)	135 x 280 x 109		135 x 390 x 109		135 x 610 x 109	
Weather Resistant	IP34					
Flame Resistant	O		O		O	
Included Accessories	U Bracket					

## FREQUENCY RANGE

• CU-21FO

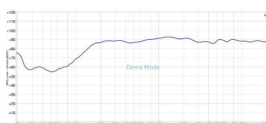

• CU-24FO

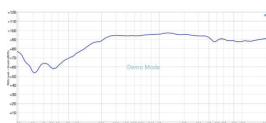

• CU-22FO

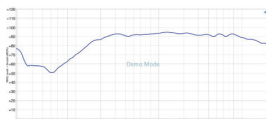

## POLAR PATTERN (1kHz/4kHz)

— 1kHz  
— 4kHz

• CU-21FO

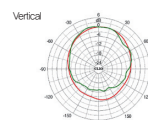
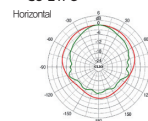

• CU-22FO

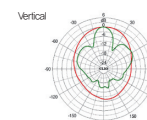
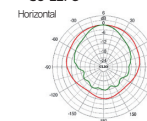

• CU-24FO

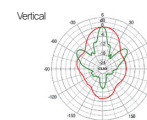
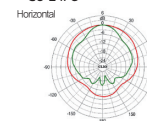

# CU-41F/42F/44F

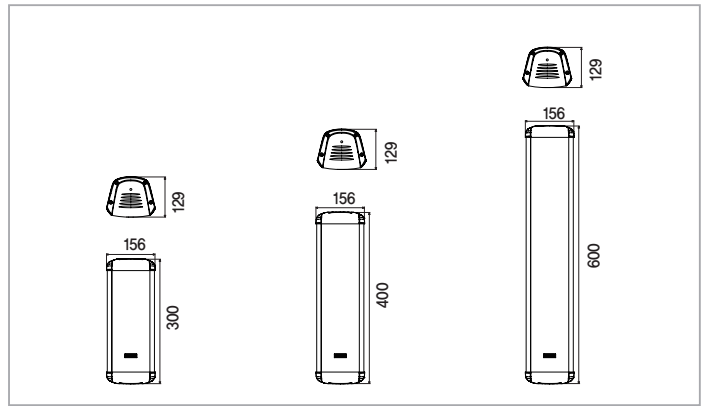

- ◆ Use 4" full-range of driver having excellent sound quality/articulation/durability
- ◆ Indoor type, 100V/70V line of high impedance steel model
- ◆ Use solid aluminum body and flame retarding grill
- ◆ Are suitable to announcement and emergency broadcasting as well as BGM play with the feature of broad frequency response
- ◆ Are installed harmoniously to the architectural design with light grey color
- ◆ Providing 3 models to choose 10W / 20W / 40W power depending on the application
- ◆ Show the maximum feature of exclusive speaker unit with the use of high-performance matching transformer produced by Inter-M
- ◆ Easy input power selection through wiring
- ◆ Provide exclusive knuckle bracket which enables the angle adjustment 30 degree downward and each 90 degree toward right and left

## SPECIFICATION

Model	CU-41F		CU-42F		CU-44F	
Type	Single 4" Full-range Column Speaker		Dual 4" Full-range Column Speaker		Quad 4" Full-range Column Speaker	
Driver	4" x 1		4" x 2		4" x 4	
Power Handling (AES)	10W		20W		40W	
Input Power	100V	10/7.5/5/2.5W	20/15/10/5W		40/30/20/10W	
Impedance	100V	1k/1.3k/2k/4kΩ	500/660/1k/2kΩ		250/330/500/1kΩ	
Power Selection	By Wiring					
Frequency Range(-10dB)	166Hz ~ 20kHz		169Hz ~ 20kHz		194Hz ~ 20kHz	
Frequency Range(-20%)	149Hz ~ 20kHz		149Hz ~ 20kHz		150Hz ~ 20kHz	
Sensitivity (1W/1m, 1kHz)	135Hz ~ 20kHz		133Hz ~ 20kHz		130Hz ~ 20kHz	
Maximum SPL[Cont]	111Hz ~ 20kHz		100Hz ~ 20kHz		97Hz ~ 20kHz	
Nominal Dispersion(HxV)	1kHz	167° x 110°	176° x 103°		146° x 53°	
	4kHz	69° x 83°	95° x 29°		70° x 15°	
Input Connector	Bi-Wired INPUT Line Direct Connection					
Enclosure Material	AL Body/ABS top, bottom Cover					
Enclosure Color	Light Gray					
Grille Material	Metal Grille					
Grille Color	Light Gray					
Weight (Net)	1.95kg		3.15kg		4.75kg	
Dimensions (Net, WxHxD, mm)	156 x 300 x 129		156 x 400 x 129		156 x 600 x 129	
Flame Resistant	O		O		O	
Certification	KS					
Included Accessories	Wall Bracket					

## FREQUENCY RANGE

• CU-41F

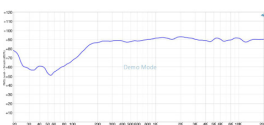

• CU-44F



• CU-42F

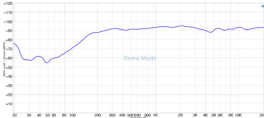

## POLAR PATTERN (1kHz/4kHz)

— 1kHz  
— 4kHz

• CU-41F

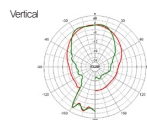
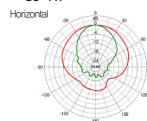

• CU-42F

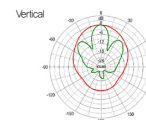
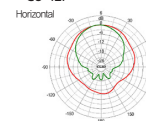

• CU-44F

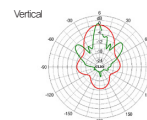
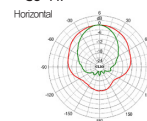

# CU-41FO/42FO/44FO

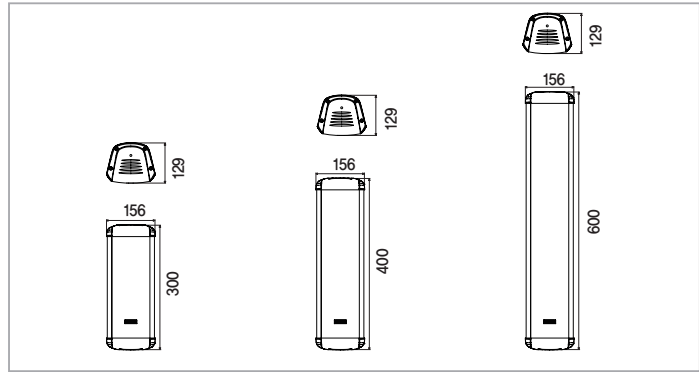

- ◆ Use 4" full-range of driver having excellent sound quality/articulation/durability
- ◆ Outdoor type, 100V/70V line of high impedance model
- ◆ Use solid aluminum body and flame retarding steel grill
- ◆ Are suitable to announcement and emergency broadcasting as well as BGM play with the feature of broad frequency response
- ◆ Are installed harmoniously to the architectural design with light grey color
- ◆ Excellent waterproof, moistureproof, and dustproof (IP34)
- ◆ Providing 3 models to choose 10W / 20W / 40W power depending on the application
- ◆ Show the maximum feature of exclusive speaker unit with the use of high-performance matching transformer produced by Inter-M
- ◆ Easy input power selection through wiring
- ◆ Provide exclusive knuckle bracket which enables the angle adjustment 30 degree downward and each 90 degree toward right and left

## SPECIFICATION

Model	CU-41FO		CU-42FO		CU-44FO	
Type	Single 4" Full-range Column Speaker		Dual 4" Full-range Column Speaker		Quad 4" Full-range Column Speaker	
Driver	4" x 1		4" x 2		4" x 4	
Power Handling (AES)	10W		20W		40W	
Input Power	100V	10/7.5/5/2.5W	20/15/10/5W	40/30/20/10W		
Impedance	100V	1k/1.3k/2k/4kΩ	500/660/1k/2kΩ	250/330/500/1kΩ		
Power Selection	By Wiring					
Frequency Range(-10dB)	135Hz ~ 20kHz		133Hz ~ 20kHz		130Hz ~ 20kHz	
Frequency Range(-20%)	111Hz ~ 20kHz		100Hz ~ 20kHz		97Hz ~ 20kHz	
Sensitivity (1W/1m, 1kHz)	88dB		90dB		92dB	
Maximum SPL[Cont]	98dB		103dB		108dB	
Nominal Dispersion(HxV)	1kHz	167° x 110°	176° x 103°	146° x 53°		
	4kHz	69° x 83°	95° x 29°	70° x 15°		
Input Connection	Bi-Wired INPUT Line Direct Connection					
Enclosure Material	AL Body/ABS top, bottom Cover					
Enclosure Color	Light Brown					
Grille Material	Metal Grille					
Grille Color	Black					
Weight(Net)	1.95kg		3.15kg		4.75kg	
Dimensions(Net, WxHxD, mm)	156 x 300 x 129		156 x 400 x 129		156 x 600 x 129	
Weather Resistant	IP34					
Flame Resistant	O		O		O	
Certification	KS		KS		KS	
Included Accessories	Wall Bracket					

## FREQUENCY RANGE

• CU-41FO

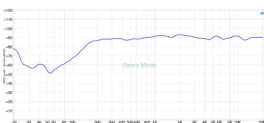

• CU-44FO

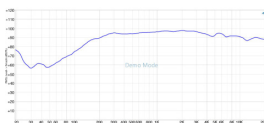

• CU-42FO

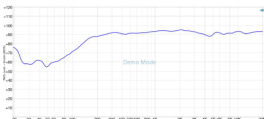

## POLAR PATTERN (1kHz/4kHz)

— 1kHz  
— 4kHz

• CU-41FO

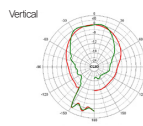
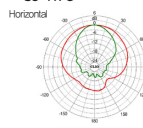

• CU-42FO

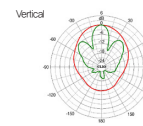
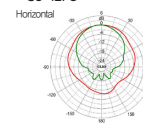

• CU-44FO

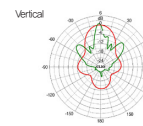
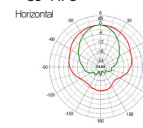

# CU-7060/7120

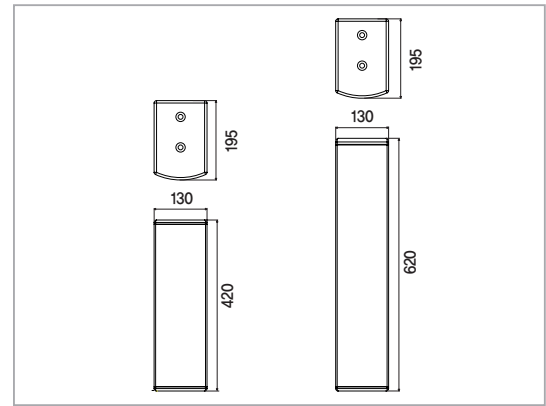

- ◆ Use unit having excellent sound quality/articulation/durability
- ◆ Indoor type, 100V/70V line of high impedance steel model
- ◆ Available to reproduce not only announcement but also high quality music
- ◆ Providing 2 models to choose 60W / 120W power depending on the application
- ◆ Applying high performance matching transformer to maximize the characteristics of dedicated speaker driver
- ◆ Screw Terminal for easy installation and connection (attached)
- ◆ Provide dedicated wall bracket which can be adjustable up to 11 degrees downward and left and right angles to 70 degrees.
- ◆ Built-in high-end tweeter which can reproduce clean and clear sound at high frequencies
- ◆ Wood enclosure

## SPECIFICATION

Model		CU-7060	CU-7120
Type		Dual 4" 2Way Column Speaker	Quad 4" 2Way Column Speaker
LF Driver		4"x 2	4"x 4
HF Driver		1"x 1	1"x 2
Power Handling (AES)		60W	120W
Input Power	100V	60/30W	120/60W
	100V	166/330Ω	83/166Ω
Impedance	100V	166/330Ω	83/166Ω
	LOW	8Ω	8Ω
Power Selection		By Terminal	
Frequency Range(-10dB)		100Hz ~ 20kHz	95Hz ~ 20kHz
Frequency Range(-20%)		55Hz ~ 20kHz	70Hz ~ 20kHz
Sensitivity (1W/1m, 1kHz)		92dB	94dB
Maximum SPL[Cont]		111dB	116dB
Nominal Dispersion(HxV)	1kHz	140° / 100°	155° / 55°
	4kHz	180° / 106°	70° / 20°
Input Connection		4P Screw Terminal	
Enclosure Material		15T MDF Polyurea Coating	
Enclosure Color		Black	
Grille Material		EGI 0.8T	
Grille Color		Black	
Weight (Net)		5.42kg	8.02kg
Dimensions (Net, WxHxD, mm)		130 x 420 x 195	130 x 620 x 195
Included Accessories		Wall Bracket	

## FREQUENCY RANGE

• CU-7060

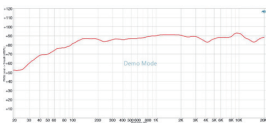

• CU-7120

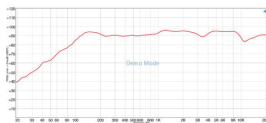

## POLAR PATTERN (1kHz/4kHz)

• CU-7060

Horizontal

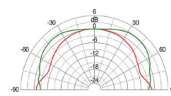

Vertical

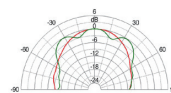

• CU-7120

Horizontal

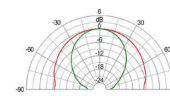

Vertical

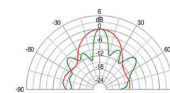

— 1kHz  
— 4kHz

# CU-9030/9060/9120

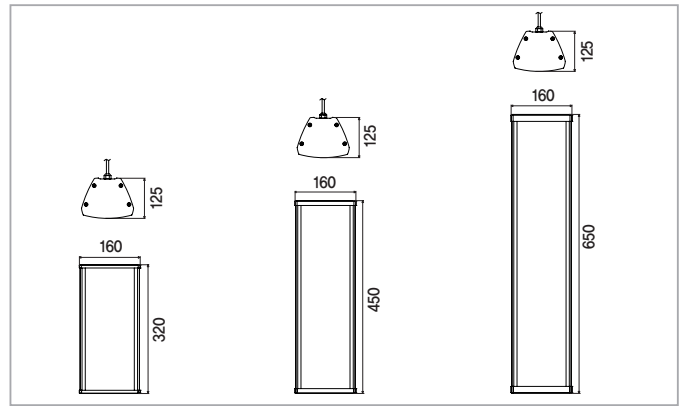

- ◆ Use unit having excellent sound quality/articulation/durability
- ◆ Use solid aluminum body and flame retarding steel grill
- ◆ Integrated aluminum galvanized steel
- ◆ Suitable for emergency broadcasting, announcement broadcasting as well as BGM playback because of excellent voice transmission performance at a long distance
- ◆ Easy-to-install design in sophisticated colors
- ◆ Excellent waterproof, moistureproof, and dustproof (IP65)
- ◆ Prevents corrosion and discoloration deformation even when used for long time
- ◆ Providing 3 models to choose 30W / 60W / 120W power depending on the application
- ◆ Applying high performance matching transformer to maximize the characteristics of dedicated speaker driver
- ◆ Easy input power selection via rotary switch
- ◆ Provide dedicated wall bracket which can be adjustable up to 11 degrees downward and left and right angles to 70 degrees.
- ◆ Built-in high-end tweeter which can reproduce clean and clear sound at high frequencies

## SPECIFICATION

Model		CU-9030	CU-9060	CU-9120
Type		Single 4" 2Way Column Speaker	Dual 4" 2Way Column Speaker	Quad 4" 2Way Column Speaker
LF Driver		4" x 1	4" x 2	4" x 4
HF Driver		1" x 1	1" x 1	1" x 1
Power Handling (AES)		30W	60W	120W
Input Power	100V	30/15W	60/30W	120/60W
Impedance	100V	330/660Ω	166/330Ω	83Ω/166Ω
Power Selection		Rotary Switch		
Frequency Range(-10dB)		115Hz ~ 20kHz	105Hz ~ 20kHz	105Hz ~ 15.5kHz
Frequency Range(-20%)		80Hz ~ 20kHz	80Hz ~ 20kHz	70Hz ~ 20kHz
Sensitivity (1W/1m, 1kHz)		88dB	90dB	90dB
Maximum SPL[Cont]		106dB	110dB	112dB
Nominal Dispersion(HxV)	1kHz	180° / 175°	180° / 90°	160° / 60°
	4kHz	130° / 110°	120° / 40°	100° / 20°
Input Connection		Bi-Wired INPUT Line Direct Connection		
Enclosure Material		Top/Bottom/Body : AL		
Enclosure Color		Metal Brown(Light Brown)		
Grille Material		EGI 0.8T / Zn-plating		
Grille Color		Metal Brown(Light Brown)		
Weight (Net)		3.09kg	4.66kg	7.05kg
Dimensions (Net, WxHxD, mm)		160 x 320 x 125	160 x 450 x 125	160 x 650 x 125
Weather Resistant		IP65		
Flame Resistant		O		
Included Accessories		Wall Bracket		

## FREQUENCY RANGE

• CU-9030



• CU-9060

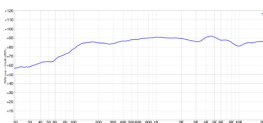

• CU-9120

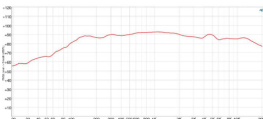

## POLAR PATTERN (1kHz/4kHz)

— 1kHz  
— 4kHz

• CU-9030

Horizontal

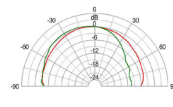

Vertical

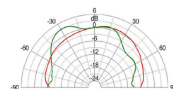

• CU-9060

Horizontal

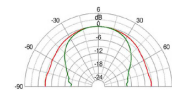

Vertical

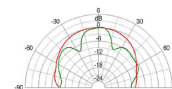

• CU-9120

Horizontal

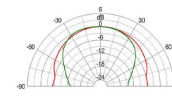

Vertical

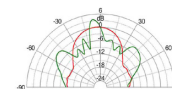

# Accessories and Brackets

Wall Bracket\_ CU-40 Series, CU-7000 Series, CU-9000 Series

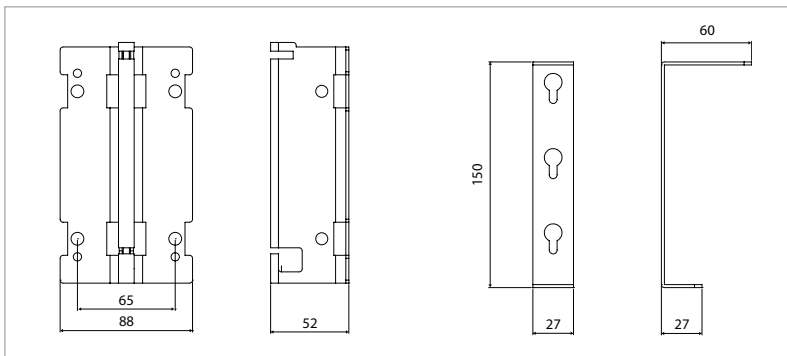
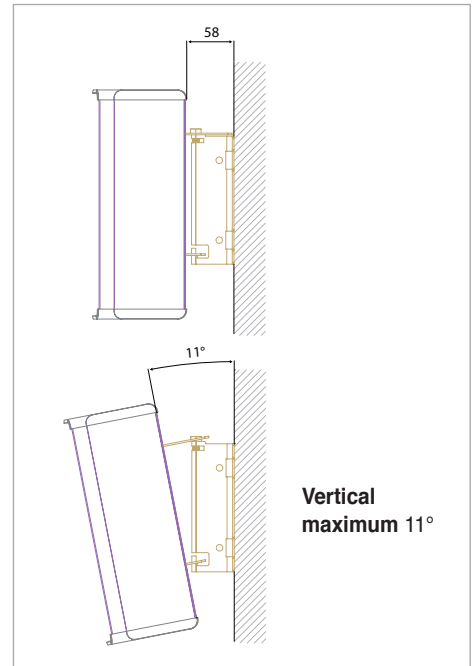
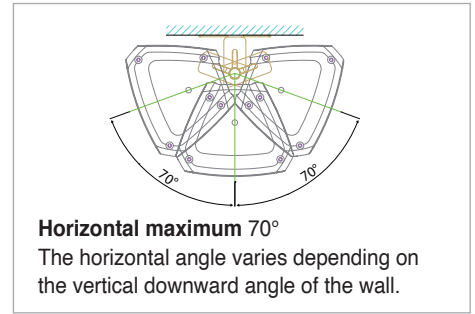
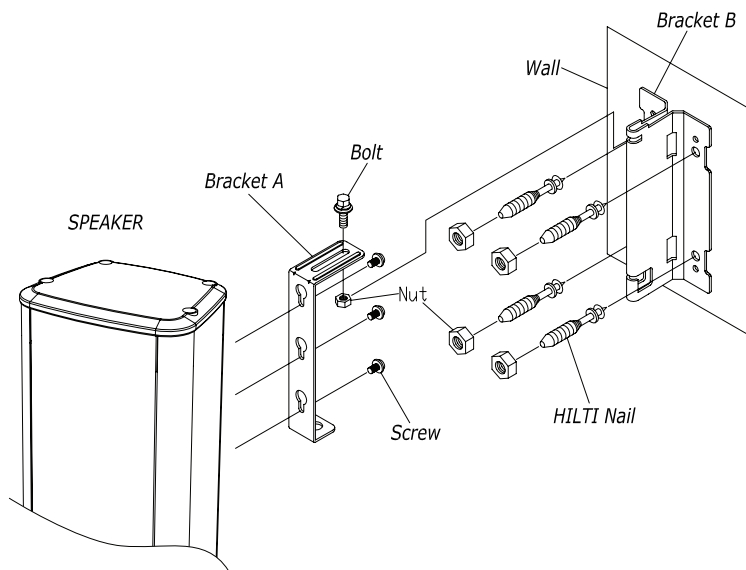

U Bracket\_ CU-20 Series, CU-40 Series

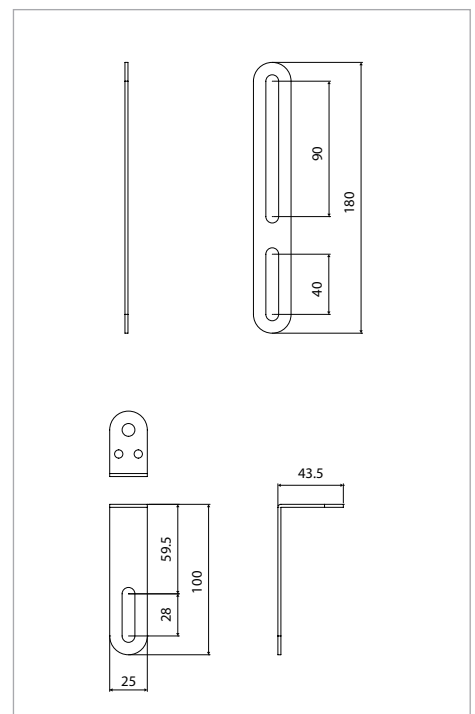
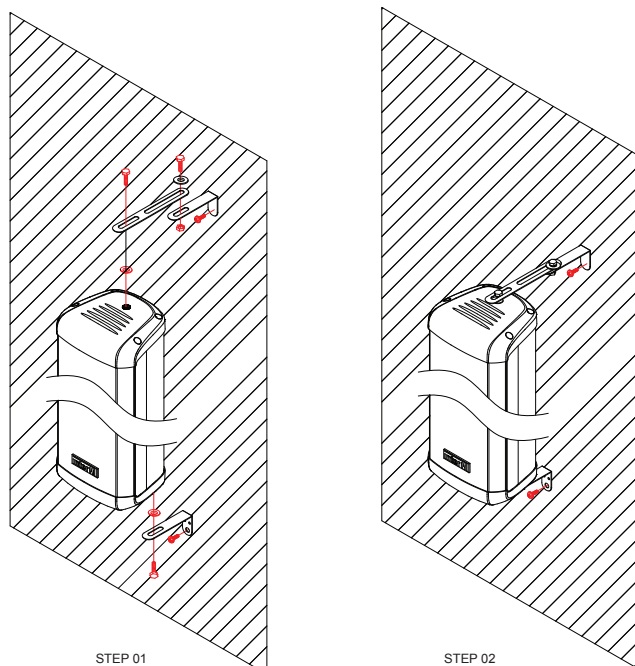



# Recommended Amplifiers for Column Speakers

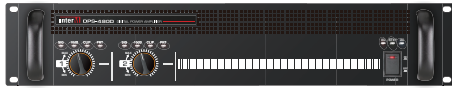

## DPS Series Digital Power Amplifier

Single Digital Amplifier : DPS-240S/360S/480S/720S  
 Dual Digital Amplifier : DPS-240D/360D/480D  
 Power : 70V, 100V Line, 8Ω  
 240/360/480/720W



## DPA Series Digital Power Amplifier

Single Digital Amplifier : DPA-300S/600S/900S/1200S  
 Dual Digital Amplifier : DPA-300D/600D  
 Triple Digital Amplifier : DPA-300T  
 Quad Digital Amplifier : DPA-150Q/300Q  
 Eight Digital Amplifier : DPA-50E  
 Power : 70V, 100V Line, 8Ω  
 50/150/300/600/900/1200W



## PA Series USB Mixing Amplifier

PA-206 : 60W  
 PA-212 : 120W  
 PA-224 : 240W  
 Power : 70V, 100V Line, 8Ω



## PM Series USB Mixing Amplifier

PM-236 : 360W  
 PM-248 : 480W  
 PM-260 : 600W  
 Power : 70V, 100V Line, 8Ω

# Use cases of digital audio matrix system of NPX system

Inter-M's CU Series is all-round column speaker that can be used both indoor and outdoor such as educational, cultural, office, and gym facilities. Our new CU Series is composed of 4 series 14 models, and provides clear voice delivery and high quality BGM playback.

In addition, through a combination of CU Series column speaker and NPX system, users can adjust the sound parameter delicately with built-in DSP, which can improve CU Series column speaker's sound quality. For example, users can control the reflection sound from the ceiling or wall which allow the listener to have more clarity, and are able to set adequate sound at right time to avoid noise from crowd especially in shipping complex, train station, and airport, by scheduling function.

Ordinary frequency characteristics of CU-20 Series provide high clarity and sound quality, and the user can achieve even better sound by using NPX system's built-in DSP.

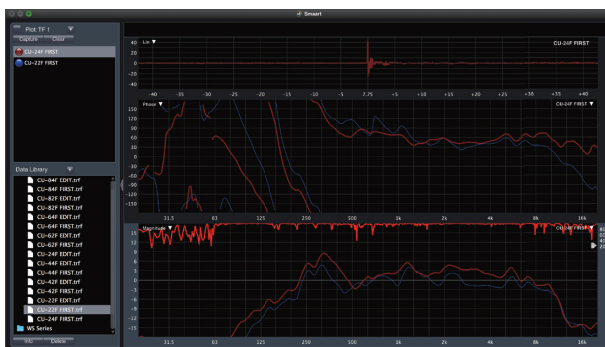

<CU-20 Series Column Speaker Original Frequency Features>

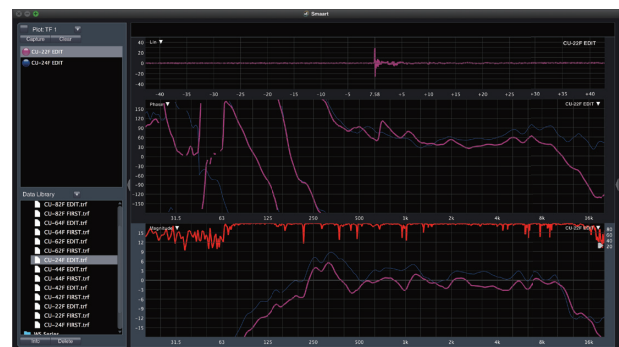

<Frequency features complementing the influence of the environment at the installation site>

# Note

# Note



**Inter-M Corp. (IMK)**

719, Dobong-ro, Dobong-gu, Seoul, Korea

Overseas Sales Team

Tel\_ +82-2-2289-8141~7 Fax\_ +82-2-2289-8149 E-mail\_ overseas@inter-m.com

[www.inter-m.net](http://www.inter-m.net)

**interM**