

BNX Series User Manual

BN1.5/1.9/2.6/2.9/3.9X

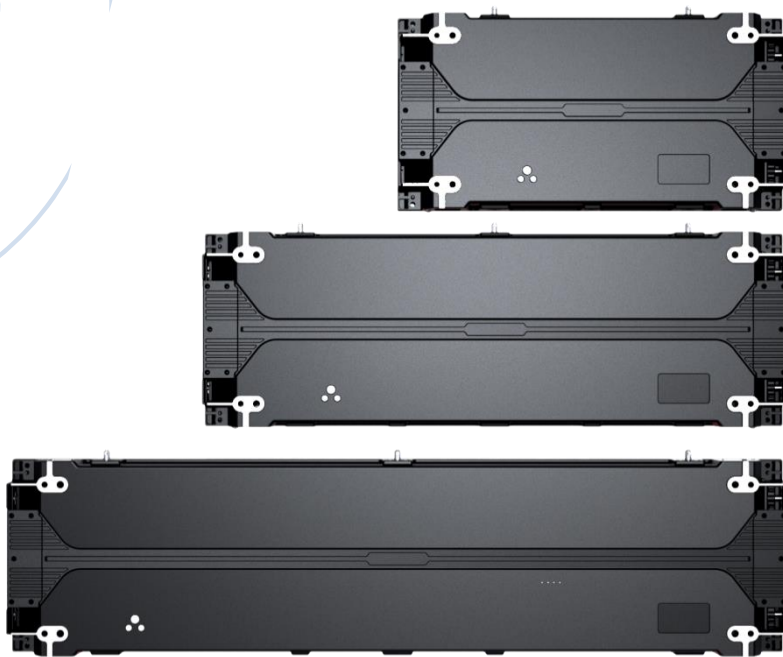

BNX Series

REV:A0
18/11/2019

This Manual is applicable to the LAMP Tech series of BNX products.

DISPLAY A BETTER WORLD FOR ALL

Table of Contents

Foreword.....	I
1. Safety.....	1
1.1 Safety Guidelines	1
1.2 Important Safety Instructions	2
1.3 Important Warnings	4
1.3.1 Important warnings.....	4
1.3.2 Highest and lowest ambient temperatures	4
1.3.3 Large current leakage may occur.....	4
1.3.4 Flammable materials	4
1.3.5 ESD & LED.....	4
1.3.6 Electric shock hazard / fire hazard	5
1.3.7 Circuit breaker equipment	5
1.3.8 Power system.....	5
1.3.9 Power cord.....	5
1.4 Proper Use	6
2. About BNX Series Products	9
2.1 Product Introduction.....	9
2.2 Product Parameters	10
2.3 Product Components.....	11
2.4 Installation Structure Section	13
2.4.1 Structure-free Installation.....	13
2.4.2 Structure Installation	14
2.4.3 Hoisting.....	15
2.5 Screen assembly	16
2.5.1 Conventional assembly of cabinet.....	16
2.5.2 Creative assembly of cabinet.....	17
2.6 Wiring	19
Signal wiring diagram and power wiring diagram	19
2.7 Product Packaging.....	20
2.8 Accessories.....	22
3. System installation.....	23
3.1 System hardware.....	23
3.1.1 Sending card.....	23
3.1.2 Receiving card.....	24
3.2 System hardware installation.....	25
3.3 Control software installation.....	26
3.4 How to set up multiple monitors.....	29
3.4.1 Intel HD graphics.....	29
3.4.2 AMD Radeon graphics (5000 series or newer).....	30
3.4.3 NVIDIA Graphics.....	32
3.5 System software configuration.....	33

3.6 Quick operation with Nova Studio.....	37
4、 Installation precautions of product	42
4.1 Installation of Display Cabinet.....	42
4.2 Testing of the Screen Power Supply System (the power supply in the power distribution cabinet and the cabinet needs to be tested by the inspectors with electrician knowledge).....	42
4.3 Precautions for Display Installation	43
5. Product Maintenance	45
5.1 Module Disassembly and Assembly	45
5.2 Disassembly and Assembly of Power Supply and Receiving Card	46
5.3 Precautions for Daily Maintenance of the Display	47
5.4 Cleaning of Fixed Display Panel.....	47
5.5 Daily Maintenance of the Screen	51
5.6 Common Troubleshooting	53
5.6.1 Method for problem determination.....	53
5.6.2 Common faults of LED display and its troubleshooting	53
6. Description on After-sales Services.....	57
6.1 Pre-sales Services (Technical Consultation).....	57
6.2 After-sales Services	57

Foreword

LAMP Tech provides this Manual in accordance with the actual product and disclaims any express or implied liability, including but not limited to implied liability or merchantability and fitness for a particular purpose. LAMP Tech may make improvements or changes to the products or programs described in this Manual at any time without notice.

This Manual may contain technical inaccuracies or typing errors. The information in this Manual will be changed periodically and will be included in the new version of the Manual.

Version & Copyright ©

All rights reserved. No part of this document may be copied, reproduced or translated. No part of this document may be recorded, transmitted, or stored in a searchable system without the prior written permission of LAMP Tech.

English Version - Warranty and Compensation

As part of the legally enforceable terms of warranty, LAMP Tech provides the relevant warranty. When receiving a product, the purchaser must immediately check for damage to all delivered items during transport and whether material and manufacturing failures have occurred. If any, you must notify LAMP Tech of the relevant issues immediately in writing. Upon approval of the notice of the issue, LAMP Tech will resolve the failure or provide a replacement plan on a case-by-case basis during the appropriate period. If the purchaser or third party modifies or repairs the items delivered by LAMP Tech, or if the items are not handled properly, especially if the system is not operated properly during the test run, or the item is affected by other factors in the contract that are not agreed upon after the risk transfer, all purchaser's warranty claims will be considered null and void. System failures due to procedures or special circuit system failures provided by the purchaser are not covered by the warranty, such as the interface. Aging and normal cleaning maintenance are not covered by the warranty provided by LAMP Tech. Customers must follow the operating environment conditions as well as service and repair specifications specified in this Manual.

English Version - Trademark





The brands and product names mentioned in this Manual are the trademarks, registered trademarks or copyrights of their respective holders. All brand and product names referred to in this Manual are used as notes or examples and shall not be regarded as advertisements of the corresponding products or other manufacturers.

Scope of application of the User Manual.

This User Manual is applicable to BNX series LED full-color display screen produced by LAMP Tech. LAMP Tech BNX series displays include **BN1.5X**, **BN1.9X**, **BN2.6X**, **BN2.9X**, **BN3.9X**.

1. Safety

1.1 Safety Guidelines

	Warning: It is important to understand and follow all safety guidelines, safety instructions, warnings, and precautions in this Manual.
	Warning: Be careful when the load is heavy.
	Warning: Please operate carefully when the load is heavy to avoid finger injury.
	Warning: Wear a safety helmet to avoid personal injury.

	Warning: Please read the following text carefully and follow the installation instructions strictly!
---	---

Installation Technician

This installation must only be performed by qualified technicians qualified or authorized by LAMP Tech. This type of display is extremely demanding on safety. Qualified installations must ensure the safety of the system in terms of site, structure, assembly, connection, use, disassembly, and transportation.

Caution

You can only begin the installation if you are fully familiar with all applicable safety checks and installation instructions. Failure to do so will increase the risk and risk of personal injury to the user. Assembly components are only suitable for assembling LED displays produced by LAMP Tech.

Do not modify or copy any components. LAMP Tech uses special materials and manufacturing processes to achieve the required part strength. For help with custom apps, please consult LAMP Tech. Be sure to follow the installation instructions provided by LAMP Tech. If you have any questions about the safety of an app, please contact LAMP Tech. LAMP Tech is not responsible for incorrect, inappropriate, irresponsible or unsafe display assembly.

Product Maintenance

Construction and assembly components should be kept dry, clean, lubricated or otherwise maintained in a manner consistent with the design features of the components. LAMP Tech products must be used in a manner that meets the design characteristics of the product. The product must be regularly inspected for safety and reliability, and for wear, deformation, corrosion, and other conditions that may affect the load handling capacity of the parts.

Safety

LAMP Tech recommends regular inspection of all installed units. For more important installations, the frequency of inspections should be increased. If the parts are damaged, the load handling capacity may be reduced and the damaged parts must be immediately removed for repair or replacement. To repair parts, please contact LAMP Tech. Under no circumstances should any other individual or entity repair the parts of the LED display produced by LAMP Tech.

1.2 Important Safety Instructions

Instructions:

- Read these instructions.
- Keep these instructions in a safe place.
- Pay attention to all warning messages.
- Follow all operating instructions.
 - Before powering up the LED display, check whether all AC power supplies are properly connected.
 - Before performing any maintenance on the LED display, turn off all power supplies, including the internal power supply of the screen, computer terminals, system boxes, etc. to ensure the safety of you and the equipment.
 - Do not press objects on cables such as power cords, signal cables, and communication cables. Cables should be prevented from being stepped on or pinched to prevent the risk of electric leakage or short circuit.
 - When replacing the module of the LED display, please hook a secure rope on the module and the corresponding panel.
 - Operating ambient humidity: At the highest operating temperature, the ambient humidity of the screen should be less than 60%.
 - Operating ambient temperature: $0^{\circ}\text{C} \leq T \leq 40^{\circ}\text{C}$.
 - Storage ambient temperature: $-40^{\circ}\text{C} \leq T \leq 60^{\circ}\text{C}$.

- The power supply must meet the requirements:

① LED display's power supply voltage: 110V ~ 220V \pm 10%; Frequency: 50HZ ~ 60HZ \pm 5%

② When the total power of the LED display is less than 5KW, it can be powered by a single-phase voltage; when it is greater than 5KW, in order to distribute the current evenly, it is necessary to be powered by a three-phase five-wire voltage.

③ The ground wire must be in reliable contact with the earth and properly separated from the N wire. The power supply to be connected should be kept away from high-power electrical equipment.

- When there is dust on the mask of the module, please clean it in time to avoid local color cast of the display.

- When maintaining the display, all the removed screws should be installed back to avoid water leakage of the display cabinet.



- Meaning of the logo: The equipment with this logo is designed and evaluated only at an altitude of 2000m. Therefore, it is only suitable for safe use at an altitude of less than 2000m, and may have potential safety hazards when used at an altitude of more than 2000m.



- Meaning of the logo: The equipment with this logo is designed and evaluated for safety only in non-tropical climates. Therefore, it is only suitable for safe use in non-tropical climates. When used in tropical climates, there may be safety hazards.

- If the steel structure of the screen body is relatively closed, it is necessary to consider the ventilation and heat dissipation of the screen body and increase the ventilation equipment. Do not exhaust the indoor warm air into the screen body.

- Use only materials or chemicals that are inert, non-abrasive, non-corrosive and leave no traces for cleaning. If you have any questions about the cleaning process, please consult the manufacturer for more advice.

- Do not block the vents, follow the manufacturer's instructions for installation.

- Do not install this equipment near heat sources such as radiators, heaters, stoves, or other devices that generate heat, including amplifiers.

- Do not neglect the safety protection of the poles or the grounding of plugs and sockets. If the supplied sockets or plugs are damaged, you must immediately take appropriate measures to replace the damaged parts.

- Do not step on the power supply, data cable, especially the plug, power outlet, and power/data cable from the device. The damaged power supply or data cable should be replaced immediately.

- Use only accessories specified by the manufacturer.

- When there is lightning, disconnect the power supply of this equipment or provide other applicable

lightning protection. If you do not use the equipment for a long time, unplug the power plug.

- Repairs should be performed by qualified technicians. When this equipment is damaged for various reasons (such as damage to the power cord or plug, equipment is not working properly, or the equipment is dropped), contact the LAMP Tech's maintenance personnel for repair.

- This equipment may only be used in conjunction with systems or peripherals specified by the manufacturer or included with the equipment. Be careful when lifting, moving, or transporting the equipment to prevent it from being damaged by tipping over.

1.3 Important Warnings

1.3.1 Important warnings

Danger of electric shock: Do not open. In order to reduce the risk of electric shock, do not remove the back cover of the cabinet. Please have qualified maintenance personnel to perform repairs.

1.3.2 Highest and lowest ambient temperatures

The maximum ambient temperature of the LED display is 40°C and the minimum ambient temperature is 0°C.

1.3.3 Large current leakage may occur

The combination of multiple unit cabinets in the installed equipment results in increased leakage current. In order to avoid the risk of electric shock caused by a large amount of leakage current, the equipment plug must be properly grounded during installation.

1.3.4 Flammable materials

Keep flammable materials away from equipment. A large amount of electrical energy is converted into heat. Ensure that the ventilation is smooth during installation so that the equipment can operate safely. Appropriate ventilation must be provided.

1.3.5 ESD & LED

The LED components used in the display are susceptible to ESD (electrostatic discharge) damage. In order to prevent damage to the LED components, wear antistatic gloves when operating (installation, disassembly, etc.). Do not touch while the equipment is running or when it is turned off.

1.3.6 Electric shock hazard / fire hazard

In order to avoid the fire caused by overload of power cable, please pay attention to the rated voltage and assembly quantity.

1.3.7 Circuit breaker equipment

When you are unable to access the power outlets of each cabinet, install a power outlet near the equipment for operation, or install accessible universal circuit breaker equipment into a fixed circuit. This equipment must be grounded. In order to prevent electric shock, the equipment should be properly grounded during installation. Do not ignore the role of the grounding plug, otherwise there is a risk of electric shock.

1.3.8 Power system

It is recommended to use a TN-S power distribution system (a power distribution system with a separate N wire and ground conductor) to avoid large ground current loops due to voltage differences in the neutral conductors. The entire electrical installation process should be protected using a power-off switch, circuit breaker, over-voltage protector, and ground-fault current interrupter with appropriate power ratings. Installation should be performed in accordance with local electrical installation specifications. If in Europe, special attention should be paid to EN 60364, it is the electrical installation standard for buildings. If in Germany, the VDE0100 specification should be followed. If in the United States, special attention should be paid to the National Electrical Code ANSI/NFPA70.

1.3.9 Power cord

The power cord supplied with this system has special security features. Users cannot repair it. If the power cord is damaged, you can only replace it with a new one. Do not try to repair the power cord.

Special precautions

1. During the handling process, please pay attention to handling it gently, and there should be no dragging or cabinet stacking, so as to avoid bumps or cracks in the module or the cabinet.
2. When plugging in the power plug, please plug in the direction of rotation of the plug. Please do not use brute force to directly plug in, and do not operate with power.
3. When replacing the spare receiving card or HUB adapter plate, make sure that the Pin angle is not skewed, and do not operate with power.
4. Please keep the inside of the flight case dry and clean. Prevent the LED lamp beads from getting damp or the cabinet from rusting due to the heavy moisture inside the flight case.

1.4 Proper Use

Proper use of the display

- Do not expose any part of the display to any moist substances.
- Do not expose any part of the display to any abrasive substances.
- Do not expose any part of the display to any dust.
- Do not expose any part of the display to any corrosive substances.
- The display should be used in an environment that complies with the operating specifications.
- The display should not be used in environments containing airborne contaminants [for example, contaminants produced by fog machines (cracked oil) or similar devices that deposit a thin layer of grease on the LED indicator optics to reduce performance].
 - The display should not be exposed to extreme heat or extreme cold conditions that exceed temperature specifications.
 - The display should not be exposed to any conditions or situations that would cause any part of the display to become hot and not function properly. Such conditions include, but are not limited to, lasers, ultrasonic vibrations, or any substances that prevent normal ventilation and heat dissipation of the display panel.
 - The display should not be exposed to the environment where moisture may condense or collect on any component.
 - The power supply connected to the display must comply with the specifications described in the installation manual.
 - When installing or disassembling the display, avoid any accidental collision at each corner of the cabinet. Since the module's LED lamps are mounted near the edges of the LED boards, the corners of the cabinet are highly susceptible to mechanical damage. Therefore, the cabinet must be handled with care at all times.
 - Do not place the cabinet or module on the surface of the LED lamp to prevent damage to the LED lamp.
 - When disassembling or installing a module, always ensure that the LED side of the module is parallel to the LED side of the remaining adjacent modules, avoiding any mechanical stress on the corners of the module.
 - Do not apply an external force to the LED. Damage to the LED lamp due to mechanical stress is not covered by the warranty.
 - The security features and functional characteristics of the display cannot be compromised.
 - It is not allowed to hang any other equipment on the back of the cabinet. It is not allowed to hang

anything on the cable of the cabinet.

- In the event of a malfunction, appropriate measures must be taken immediately (whether the equipment is returned). The failed equipment cannot be allowed to continue to run.
- The components can only be connected using the cable specified for this display. In addition, be careful to connect the signals only as described in the installation manual.
- The display should not be used near equipment that is not certified by 3C, CE, and UL/ETL.
- When reconnecting the components of the display, it must be wired in strict accordance with the installation manual to prevent damage to the cables or other parts of the cabinet.
- In order to disassemble the module, you need to gently push the module from the back to avoid forced unraveling.
- In addition to LAMP Tech's flight case or unit packaging box, other shipping tools should not be used to transport the cabinet. In addition, even if transported using LAMP Tech's flight case or packaging materials, there is no guarantee that the cabinet will not be damaged by excessive force. Packaging materials can be ordered from LAMP Tech. All warranty claims for damage to the cabinet due to incorrect packaging are null and void.
- The LED module mask can only be removed using the approved mask removal method described in the installation manual.
- Clean the cabinet only in accordance with the procedures specified in the instruction manual.

Precautions

1. When opening the screen, please turn on the computer before turning on the LED display. When the LED display is powered on, there will be a regional flashing, indicating that the screen is energized. When the screen is off, first turn off the power of the LED screen, then turn off the control software, and finally turn off the computer.
2. The newly installed LED display must be tested on the screen for the following operating procedures:
 - A. When starting up for the first time, the screen brightness is set to 10% and keep this brightness for 2 hours. Shut down for half an hour, then start up again and run according to this setting. Execute the program for 4 cycles.
 - B. After completing Step 1 above, set the screen brightness to 30% and keep 30% of the screen brightness for 8 hours. Shut down for 1 hour, then turn it on again and run according to this setting. Execute this program for 2 cycles.
 - C. After completing Step 2 above, set the screen brightness to 50% and keep 50% of the screen

brightness for 8 hours. Shut down for 1 hour, then turn it on again and run according to this setting. Execute this program for 2 cycles.

D. After completing Step 3 above, set the screen brightness to 70% and keep 70% of the screen brightness for 8 hours. Shut down for 1 hour, then turn it on again and run according to this setting. Execute this program for 2 cycles.

E. After the above test run is completed, set the screen brightness to 100%. Start running for 2 hours and monitor whether the screen functions normally. After everything is normal, set the items such as screen on/off time, time period brightness switching, screen power temperature monitoring, screen communication monitoring, etc. according to customer requirements.

3. The LED screen has been installed. If it is not turned on for a long time, the video will be aging. The aging process refers to the newly installed LED screen's trial operation procedure.
4. For the calibration effect maintenance of the corrected display, please refer to the calibration maintenance manual attached to our CD-ROM.

2. About BNX Series Products

2.1 Product Introduction

BNX series includes spaces of five points 1.5, 1.9, 2.6, 2.9 and 3.9, meeting space demands among indoors fixed installation mainstream points.

Cabinet size: 500*250mm, 750*250mm , 1,000*250mm and 500*1000 。

The product adopting the full die-casting aluminum cabinet is integrated to ensure the cabinet flatness, while making the whole product simple and generous; the cabinet is ultra-thin, only 48mm thick, fully installed in the front, conveniently and quickly; The 750*250mm cabinet only weighs 5.1kg, while the magnetic absorption module, simple in installation and maintenance which can save time and reduce the lamp collision rate; the module can be installed by rotating along 90° to avoid the color difference caused by rotation of the cabinet. The cabinet can be spliced alternatively with 125mm as the unit; 45° chamfered cabinet can be optional; arc scheme can be optional, 0-270° arc can be made crosswise, 0-10° internal/external arc can be made vertically, to meet the needs of more creative scenes; double backup for power and loop backup for signal can guarantee the display stability of the screen; optional high cost-effective schemes, including 2+3, 3+3 schemes, one power supply and one receiving card are equipped for two cabinets;

The module, power supply and control card are maintained from the front. Therefore, no maintenance channel is required. At the same time, the cabinet is engraved with marks to facilitate quick positioning of power supply and receiving card.

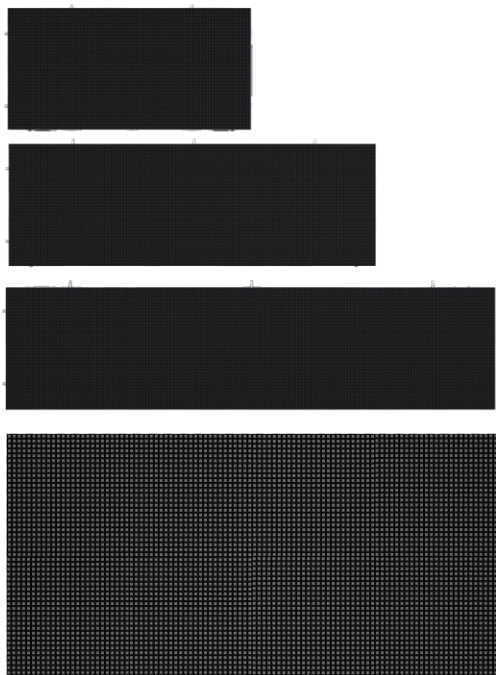

Front View

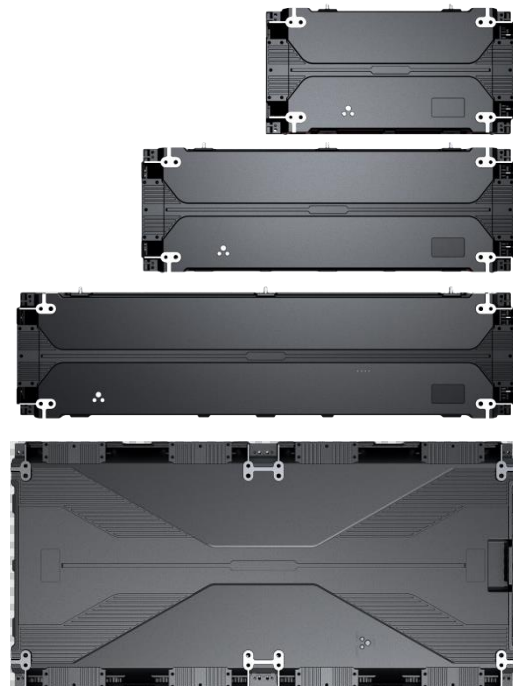

Dorsal View

2.2 Product Parameters

Product specification parameters:

Parameter		Value				
Physical Parameter	Pixel Configuration	SMD1010	SMD1010	SMD2020	SMD2020	SMD2020
	Pixel Pitch (mm)	1.5	1.9	2.6	2.9	3.9
	Module Resolution	160x160	128X128	96x96	84X84	64X64
	Pixel density (pixels/sq.m.)	409,600	262,144	147,456	112,896	65,536
	Cabinet Dimensions (WxHxD)/ (mm)	500/750/1000x250x48			500x1000	
	Module Dimensions (WxH)/ (mm)	250x250				
	Panel material	Die Casting Aluminum				
	Cabinet weight (kg/panel)	3.7/ 5.1/ 6.3			12.5	
	Module weight (kg/panel)	0.45				
	Electronic Parameter	Color Grayscale (Bit)	13-15bit			
Gray Scale per Color (level)		8192-32168				
Refresh Rate (Hz)		1920-2880		1920-3840		
Driving Type		1/32	1/32	1/24	1/21	1/16
Signal Transmission Distance (m)		CAT5 cable: < 100 m; Single mode fiber: < 10 km				
Optical Parameter	Brightness (nits)	600	600	1000	1000	1000
	Optimal Horizontal Viewing Angle (°)	160	170	150	145	150
	Optimal Vertical Viewing Angle (°)	Up:70 down:75	Up:70 down:70	Up:50 down:60	Up:55 down:55	Up:50 down:50
Electrical Parameter	AC Input Voltage (V)	AC: 100V ~ 240V				
	AC Input Power Maximum Value (W/ m ²)	383	480	550	508	419.73
	AC Input Power Typical Value (W/ m ²)	128	160	185	169	138.5
Circumstance Parameter	Storage Temperature (°C)	-40 -60				
	Working Temperature (°C)	0-40				
	IP rating (Front/Rear)	IP40/IP20				
	Storage Humidity (RH)	10%~90% non-condensing				
	Working Humidity (RH)	10%~60% non-condensing				
Installation	Cabinet installation	fix				

- Remark: 1. Power consumption tolerance: $\pm 15\%$, according to the actual situation.
 2. The ambient humidity for storage in the specification refers to the unopened.
 3. The viewing angle here refers to the angle between sight line and normal line.
 4. Shenzhen LAMP Technology Co.,Ltd. reserves the right to modify specifications and parameters without prior notice.

2.3 Product Components

Cabinet Section

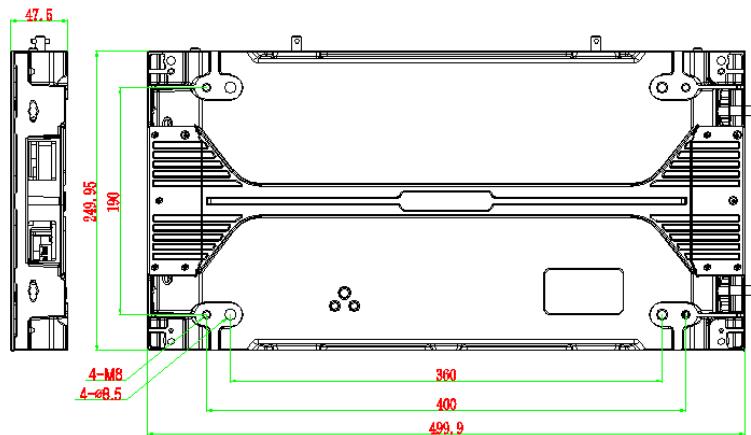

500×250mm Cabinet

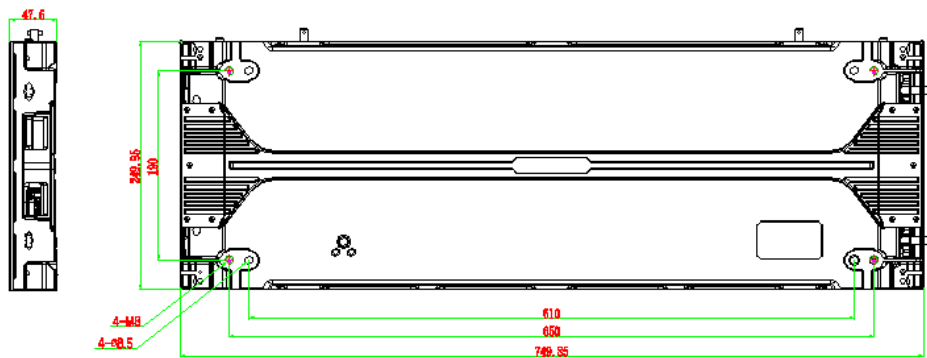

750×250mm Cabinet

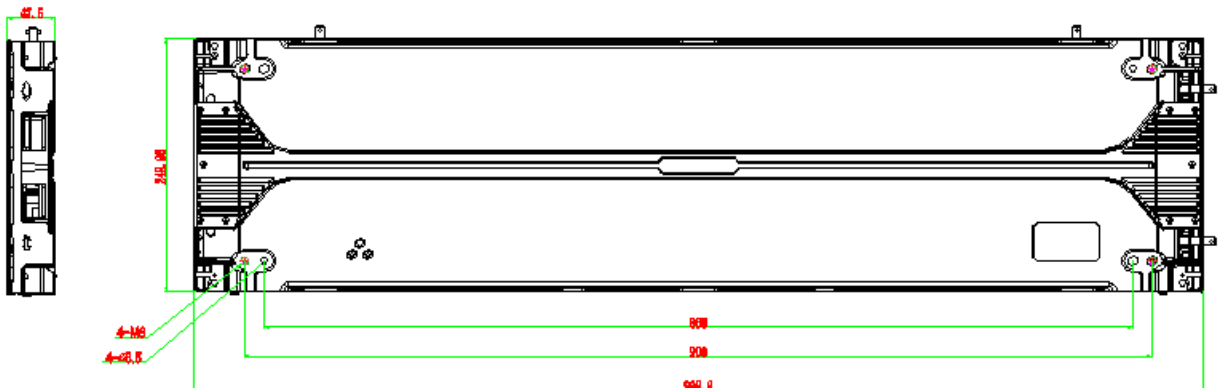

1000×250mm Cabinet

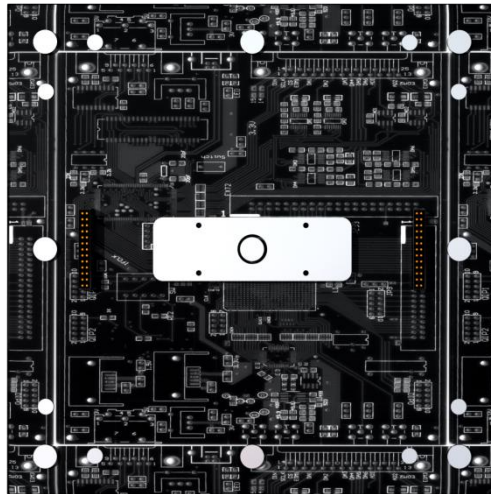

Module Section

Cable Section

Cascade signal cable between cabinets (CAT5 OR CAT6)

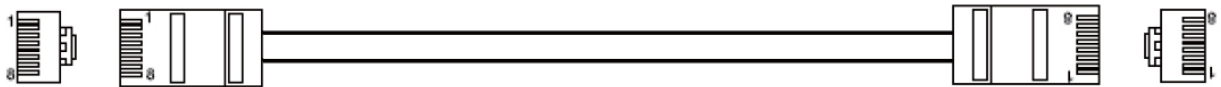

Cascade power cord between cabinets

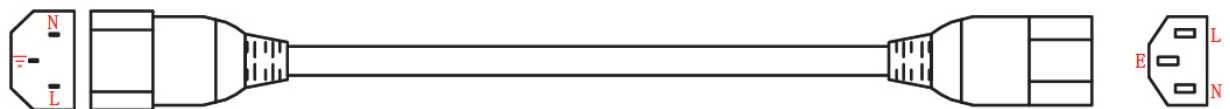

Main power cord

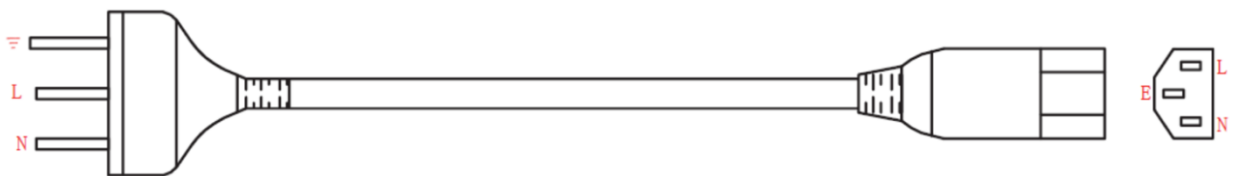

2.4 Installation Structure

2.4.1 Structure-free Installation

This wall-mount product can be directly fixed by self-tapping screws without steel structure. The specific steps are as follows:

1. Drill the mounting holes;
2. Remove the modules at the left and right ends of the cabinet.
3. Put the self-tapping screws or expansion screws through the holes at both ends of the cabinet and fix it on the wall;
4. Connect the wires and put the modules back.

M6
self-tapping
screw

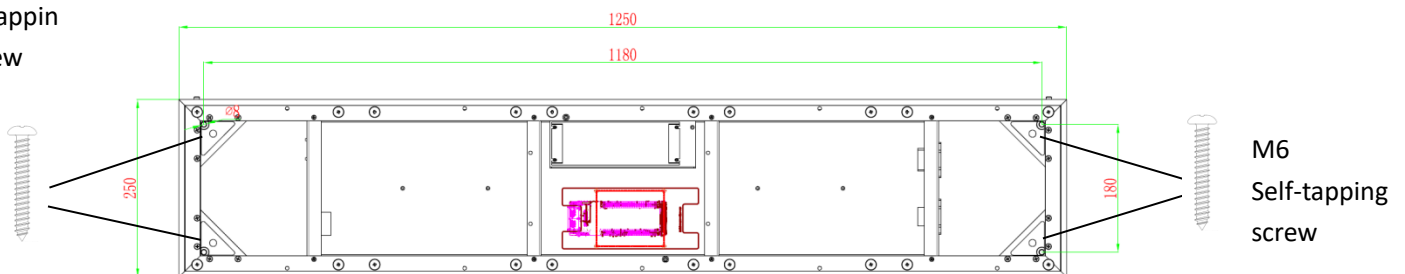

M6
Self-tapping
screw

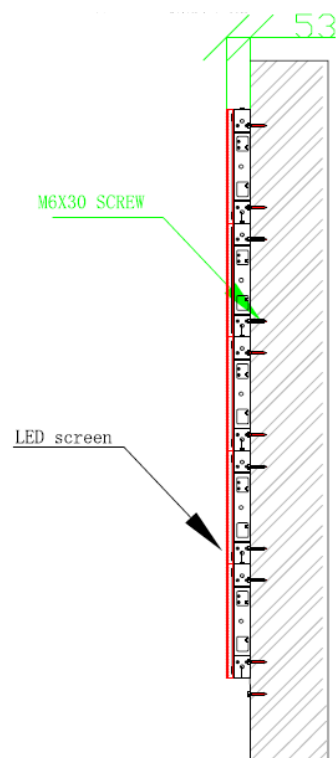

2.4.2 Structured Installation

Shenzhen Lamp Technology Co., Ltd will provide clients with steel-structured installation drawings and steel structures based on the specific situation of each project. The installation of steel structure is shown as follows(the following steel structure and screen dimension are only used for demonstration):

1. Identify the position of the screen and fix the horizontal structure on the wall with M8*100 self-tapping screws or expansion screws;
2. Connect the vertical and horizontal structure with corner braces;
3. Remove the modules at both ends of the cabinet and fix the cabinet to the vertical structure with connecting pieces and M8*60 screws;
4. Connect the wires and put the modules back.

aluminum
corner brace

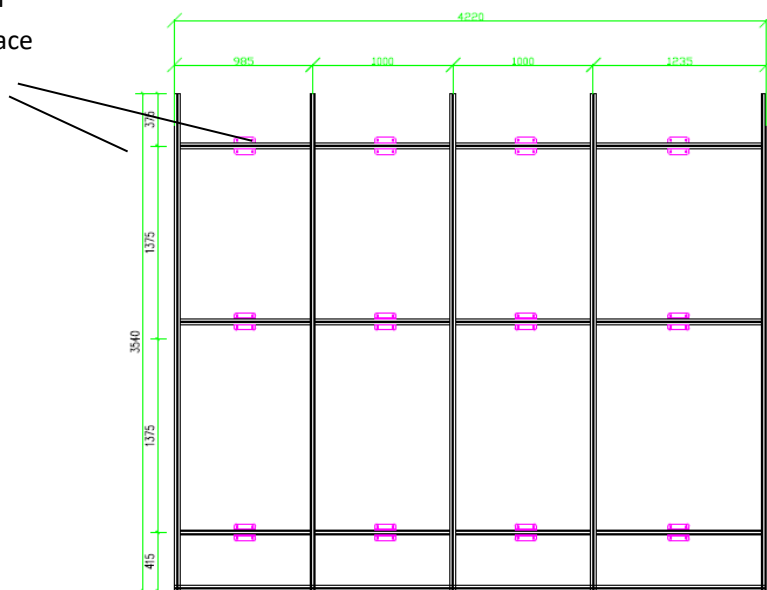

Front view

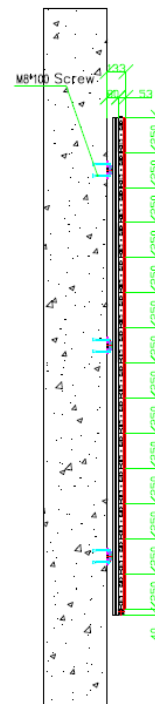

Side view

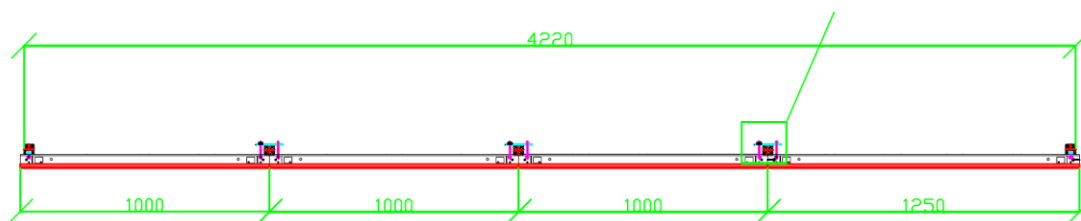

Top view

2.4.3 Hoisting

BNX series are designed with matched hoisting beam for hoisting.

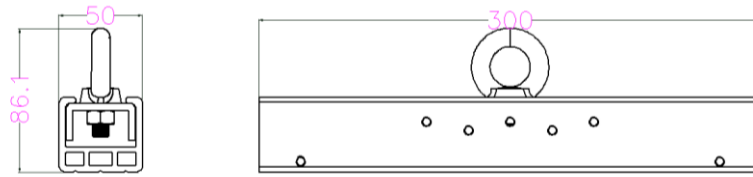

Hanging beam for 500*250mm cabinet (unit: mm)

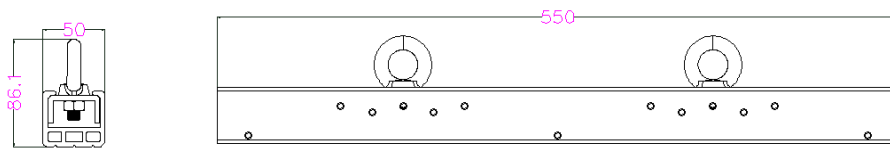

Hanging beam for 750*250mm cabinet (unit: mm)

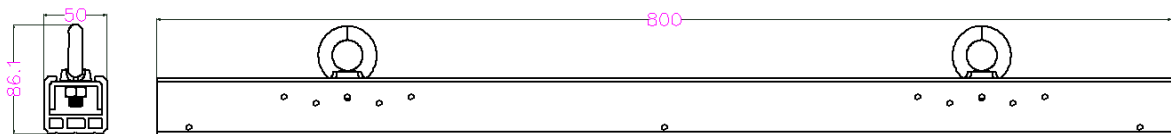

Hanging beam for 1000*250mm cabinet (unit: mm)

2.5 Screen assembly

BNX series cabinet support a variety of splicing methods: horizontal and vertical splicing of cabinet with same/different dimensions, stagger splicing of cabinets with same/different dimensions, and also creative splicing.

2.5.1 Conventional assembly of cabinet

Vertical and horizontal assembling of cabinets with same/different dimensions

To assemble two cabinets adjacent vertically, the location pin of the upper cabinet must be aligned with the location pin hole of the lower cabinet and placed vertically on the lower cabinet to prevent damage/destroy to the cabinet caused by tilting.

To assemble two cabinets adjacent horizontally, the two crosswise adjacent locking members shall be aligned with and passed through the corresponding locking holes for locking to prevent tilting.

Connection instruction of cabinet:

1. During front installation, the cabinets are mutually connected with locks and then install the modules.
2. During rear installation, it is unnecessary to remove the module. Connect the cabinet with locks and then adjusted the flatness properly.

Operation requirements:

1. During installation, cabinets must be connected firmly to guarantee the verticality of each row.
2. Inspect whether the cabinets among different rows are firmly locked.

2.5.2 Creative assembly of cabinet

LAMP BNX series of cabinets are designed with several screw hole at the bottom so that cabinets with same/different sizes can be spliced staggerly in the unit of 125mm.

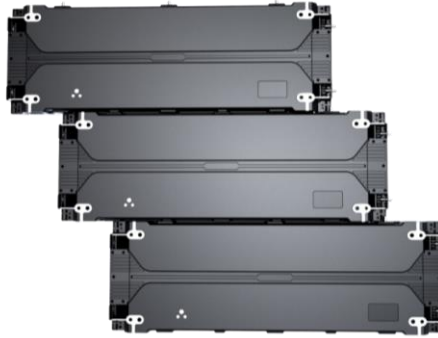

Stagger splicing of cabinets with same dimension

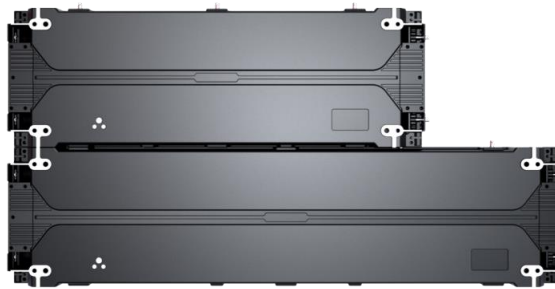

Stagger splicing of cabinets with different dimensions



Splicing horizontally and vertically



Cabinets can be mixed combined with GN-PLUS to make more multiple appearance

2.6 Wiring

The power supplies between BNX series cabinets are connected with triangular butt joint, one is for input and the other is for output; the signals are connected with RJ45 butt joints (Cat.5e or Cat.6e). One is for input and the other is for output (any port can be taken as input or output).

Please refer to the cabinet wiring diagram delivered with the goods for the panel wiring mode.

For example:

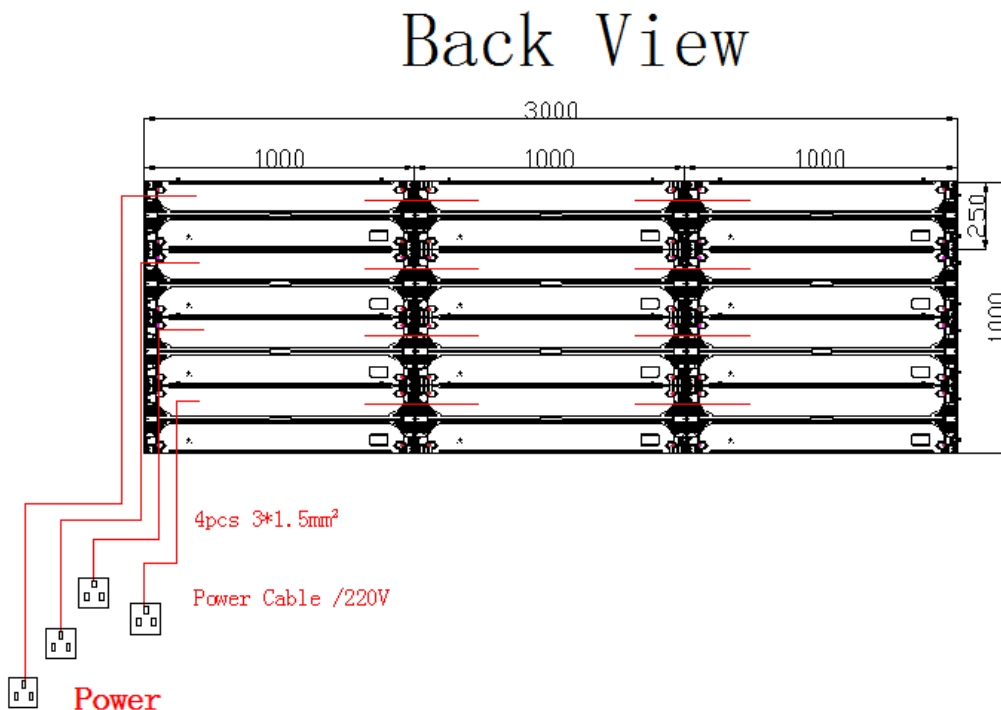
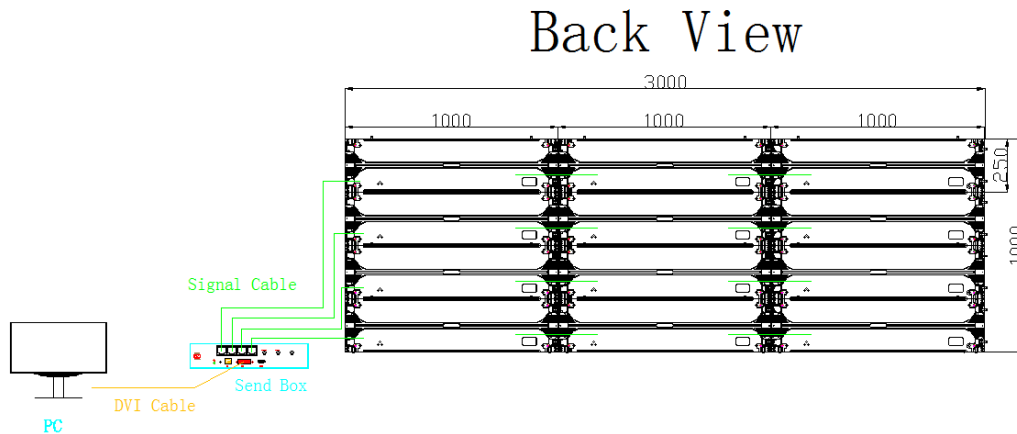

2.7 Product Packaging

Regarding this series of products, the modules and cabinets are packed separately. The cabinets are packed and transported in wooden cabinets or heavy-duty cartons. One wooden cabinet or heavy-duty carton can be filled with five cabinets. Dimensions of wooden boxes and heavy-duty cartons can be customized. The modules are packed in pearl cotton boxes, and then packed in module cartons. One module carton can be filled with 16 modules. One module wooden box can be filled with six module cartons.

Product packaging includes antistatic bags, pearl cotton boxes, wooden boxes, heavy cartons, cartons, desiccants, etc.

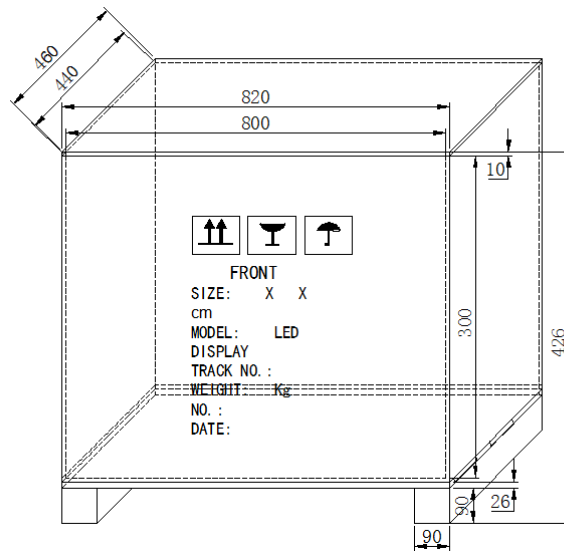

five in one wooden boxes (unit in the figure: mm)

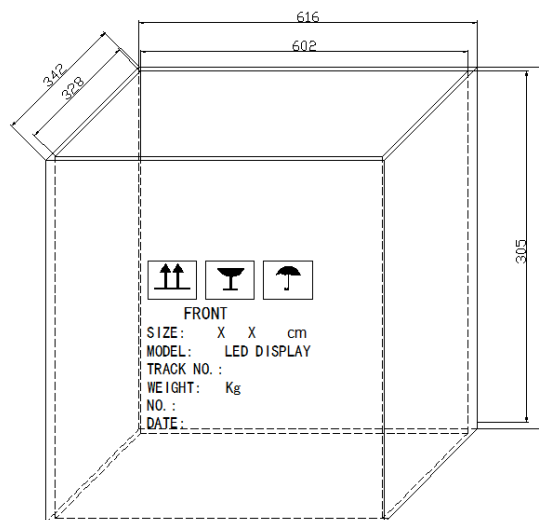

Module Carton (unit: mm)

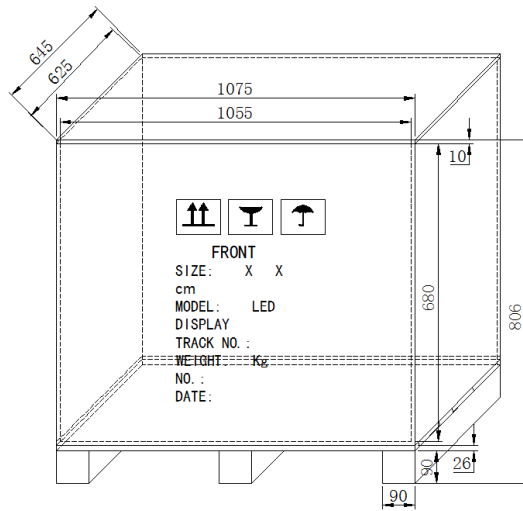

Module Carton and Wooden Box (unit: mm)

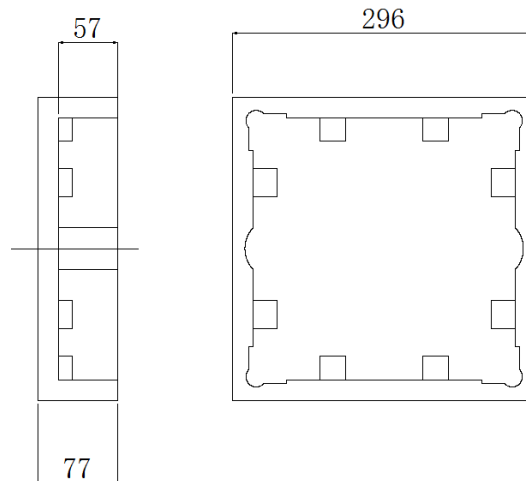

Pearl cotton box (unit: mm)

2.8 Accessories

Front maintenance magnetic tool

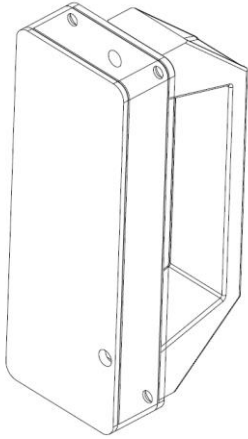

Negative pressure tool for front maintenance

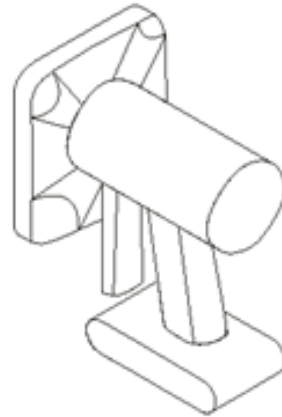

Arc connection strap

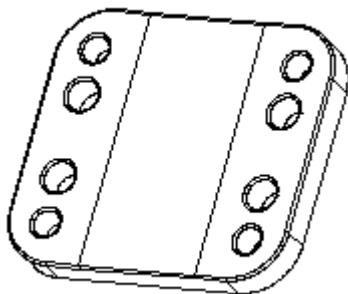

3. System installation

3.1 System hardware

The main controller for this controlling system includes sending card, receiving card, and HUB board. Details are as following:

3.1.1 Sending card

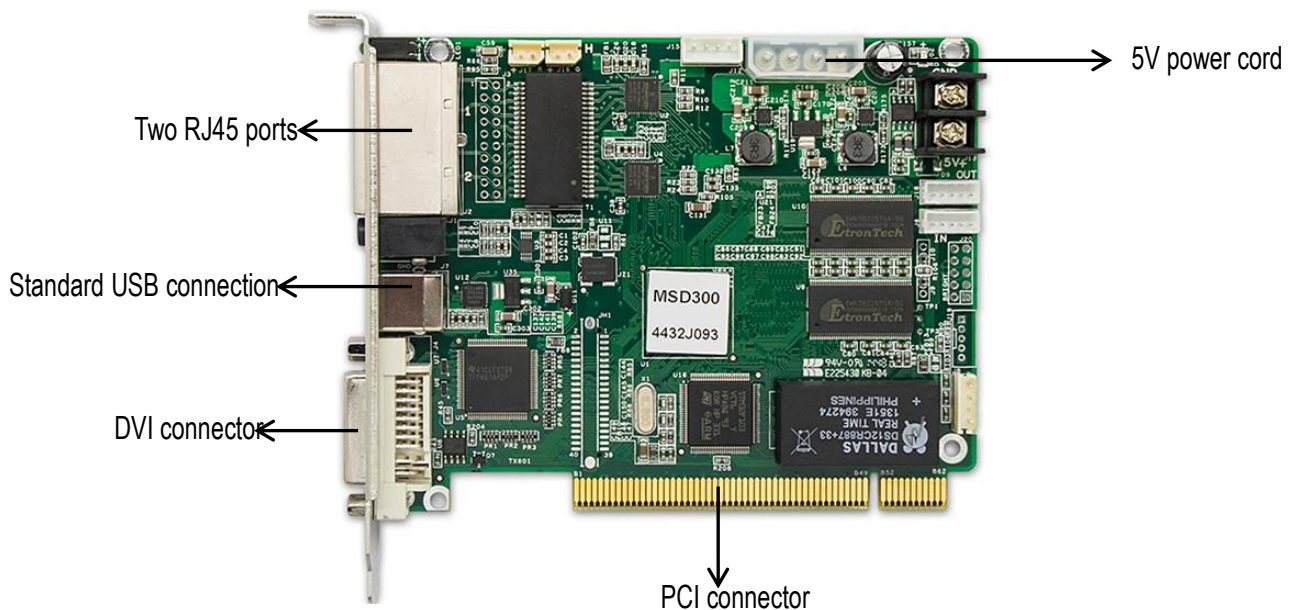

NO.	Name	Function
1	PCI Connector	The sending card could insert into computer PCI slot by this connector. PCI slot only provide 5V DC to sending card.
2	DVI connector	Connect to the computer graphic card DVI output with the DVI cable.
3	Two RJ45 ports	Main data output ports. The one close to the USB port is 2 nd PORT. The other one is 1 st PORT. These ports are connected to receiving card by cat-5 cable.
4	Standard USB connection	Connect to computer USB port.
5	5V power cord	Sending card can be powered by this cord using 5V power supply instead of installing in computer sometimes.

3.1.2 Receiving card

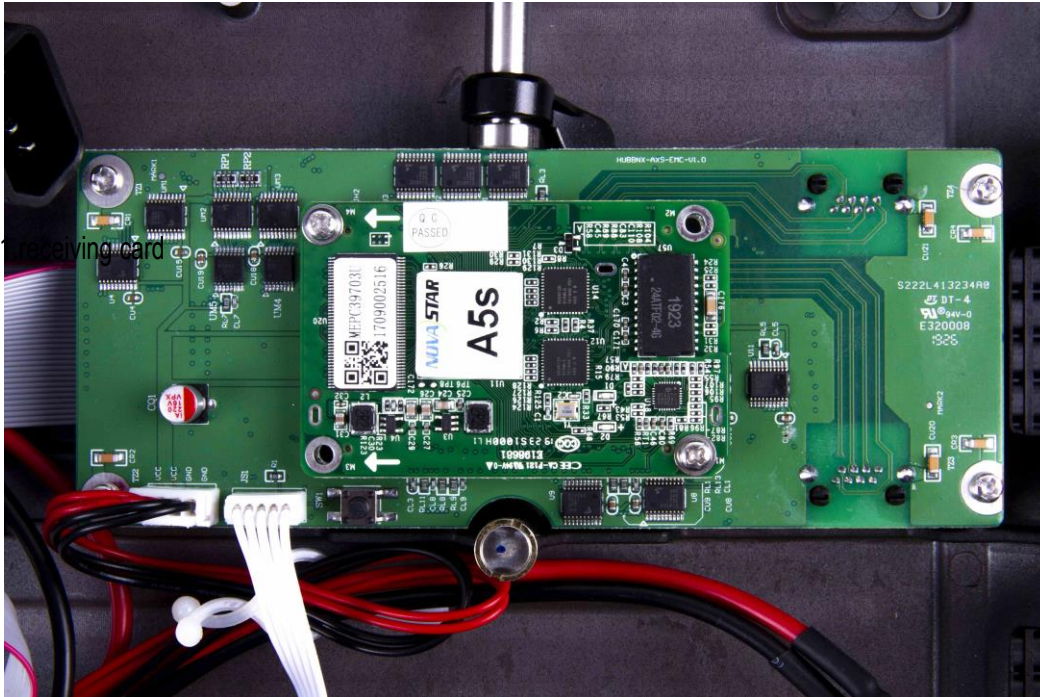

NO.	Name	Description
1	Receiving card	NOVA A5S receiving card
2	Output connector	Connect to modules by flat cable
3	RJ45	Signal connector ,connect to sending card or reciving card by CAT5 cable

3.2 System hardware installation

1. Install the DVI graphic card in the computer, and then install the driver for

the graphic card.

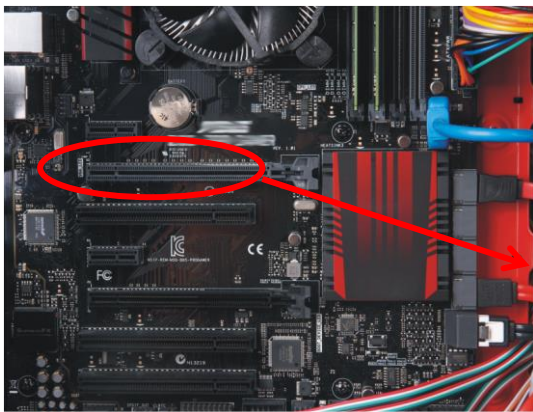

Graphic card- rear view



Graphic card- front view

2. Install the sending card in the computer

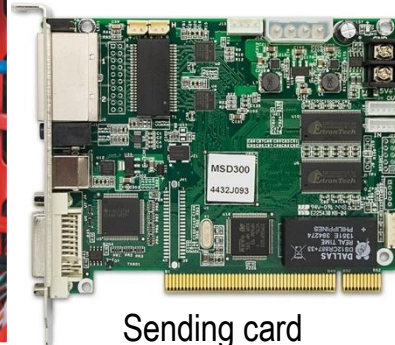
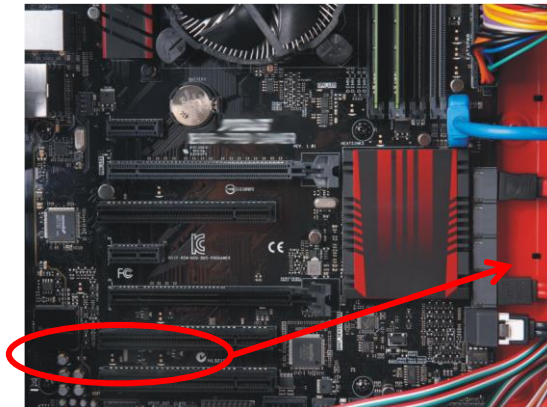

Sending card

3. After installing these, the computer shows like this:



Graphic card

Sending card

4. Then we can connect the cables within computer and cards. First connect USB cable from computer USB port to sending card USB port. Then connect DVI cable from graphic card to sending card DVI port. Then connect CAT-5 cable from sending

card 1st port to first cabinet.

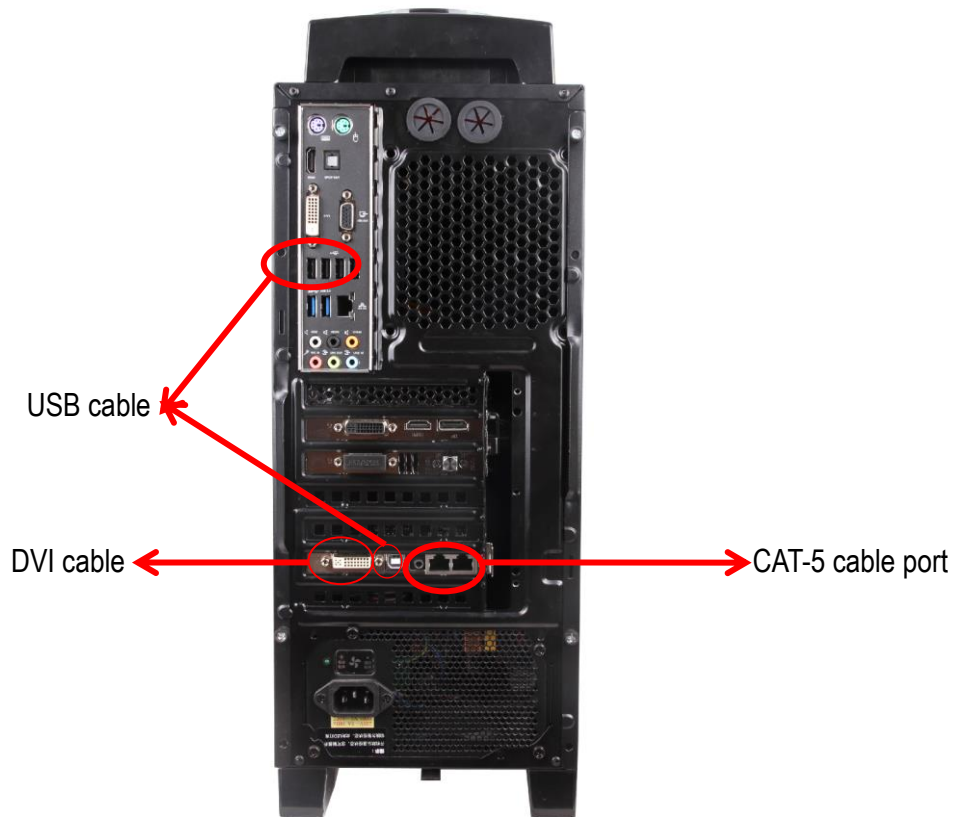

3.3 Control software installation

1. Double clicks the setup file.

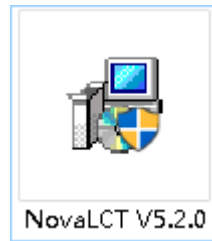

2. Select the English language. Then click “”

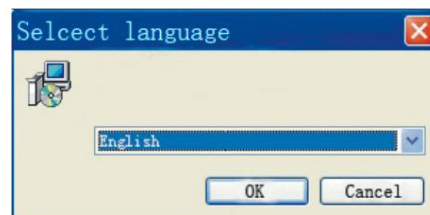

3. Click “Next” four times.

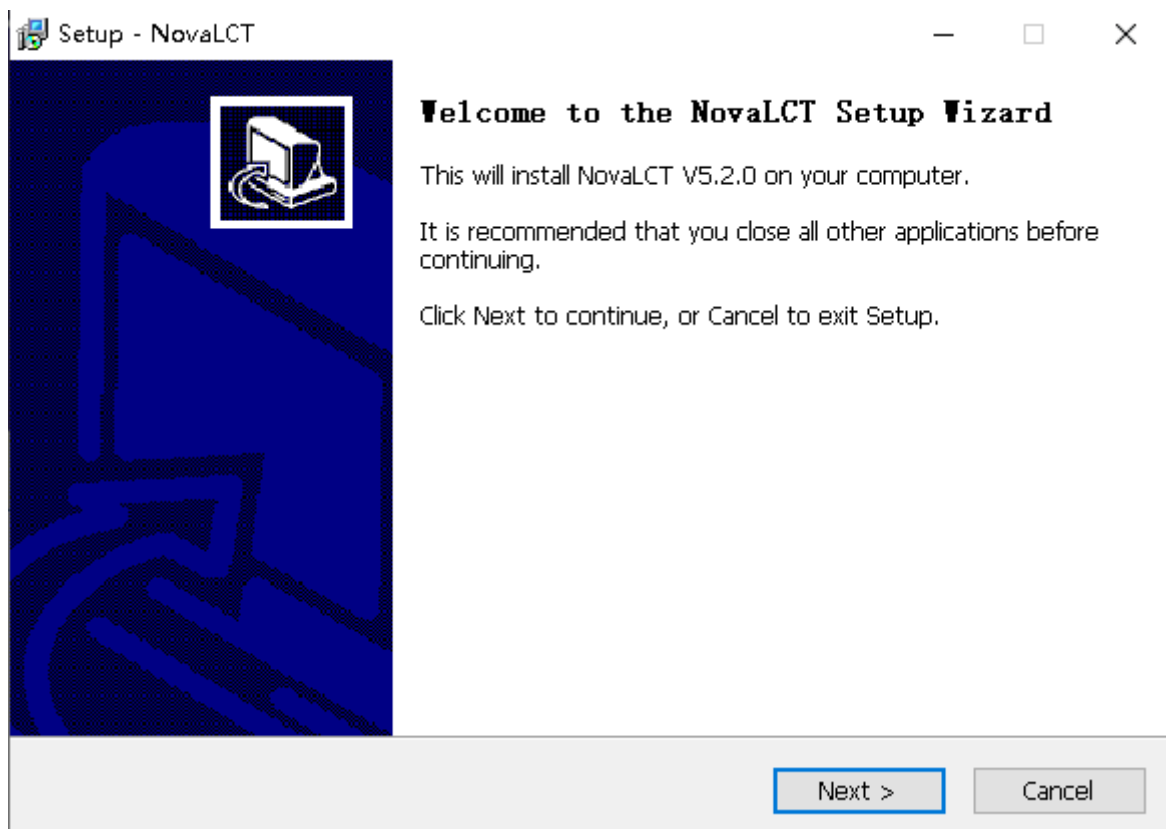

4. Click “Install”.

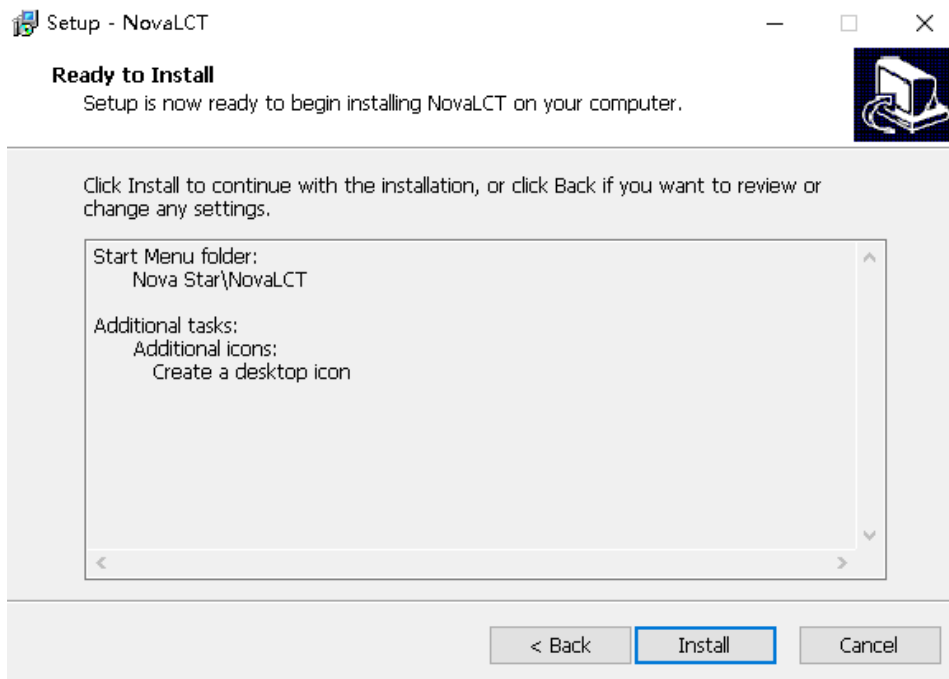

5. Click “Finish” and then the “NovaLCT” will be installed.

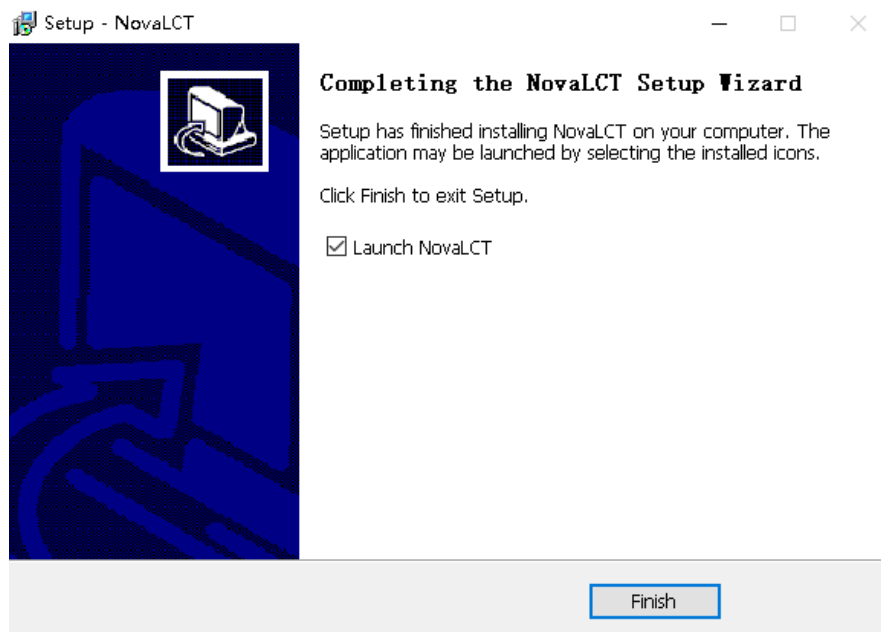

3.4 How to set up copy modes

Please choose one suitable for you from three graphic cards setups, as follows:

3.4.1 Intel HD graphics

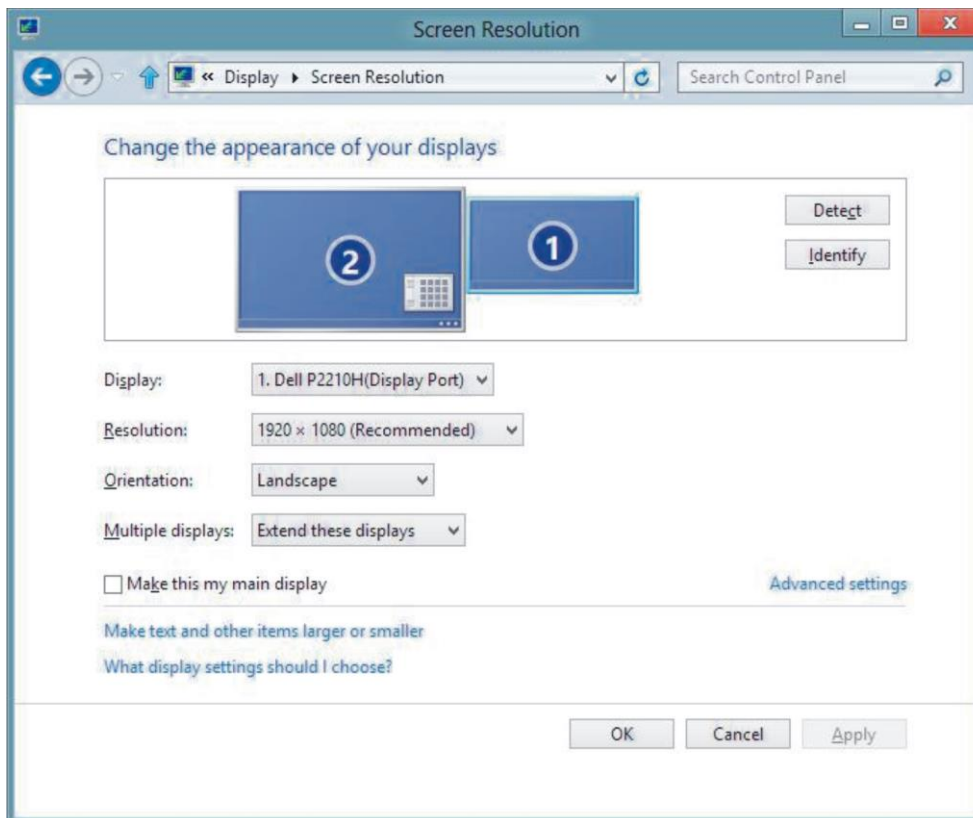

To configure the monitors' positions,

1. Right-click the desktop, and then choose Personalize from the menu.
2. In the resulting window, click the Display, and then click Change Display Settings
3. In the Change Display Settings window, click and drag the virtual monitors to mimic your physical setup.
4. Click OK, and you're done.
5. Another way to bring up the necessary control panel is to open your Start menu and enter Display Settings in the search field.

3.4.2 AMD Radeon Graphics (5000Series or Newer)

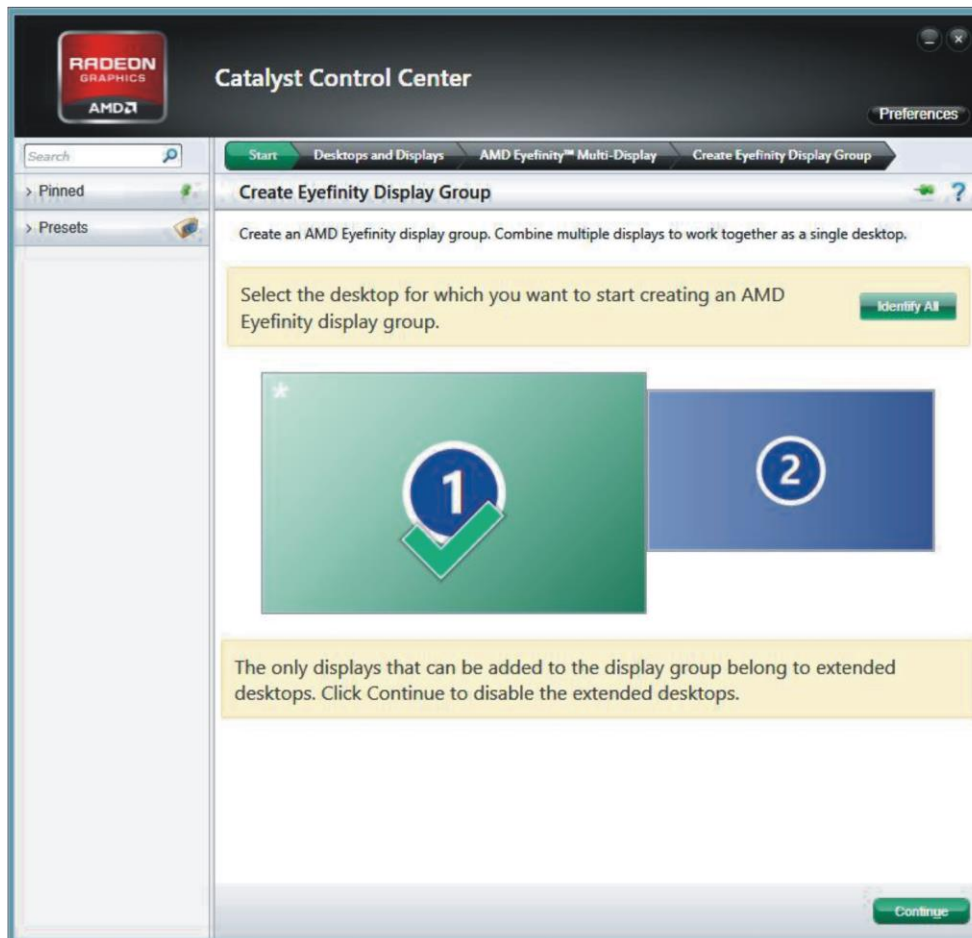

1. We recommend pointing your browser to AMD.com, and downloading and installing the latest drivers from the company's site.
2. The subsequent setup process for a basic multi-monitor configuration is identical to the one for Intel's integrated graphics.
3. Users can configure to treat multiple monitors as a single, large surface.

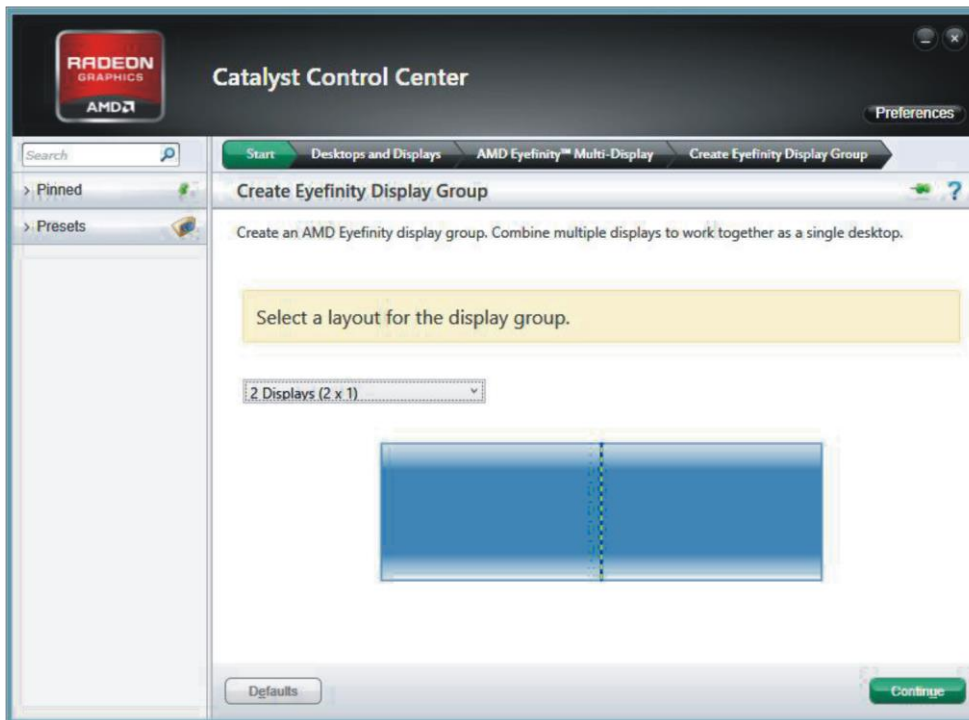

1. We recommend pointing your browser to AMD.com, and downloading and installing the latest drivers from the company's site.
2. The subsequent setup process for a basic multi-monitor configuration is identical to the one for Intel's integrated graphics.
3. Users can configure to treat multiple monitors as a single, large surface.

3.4.3 NVIDIA Graphics

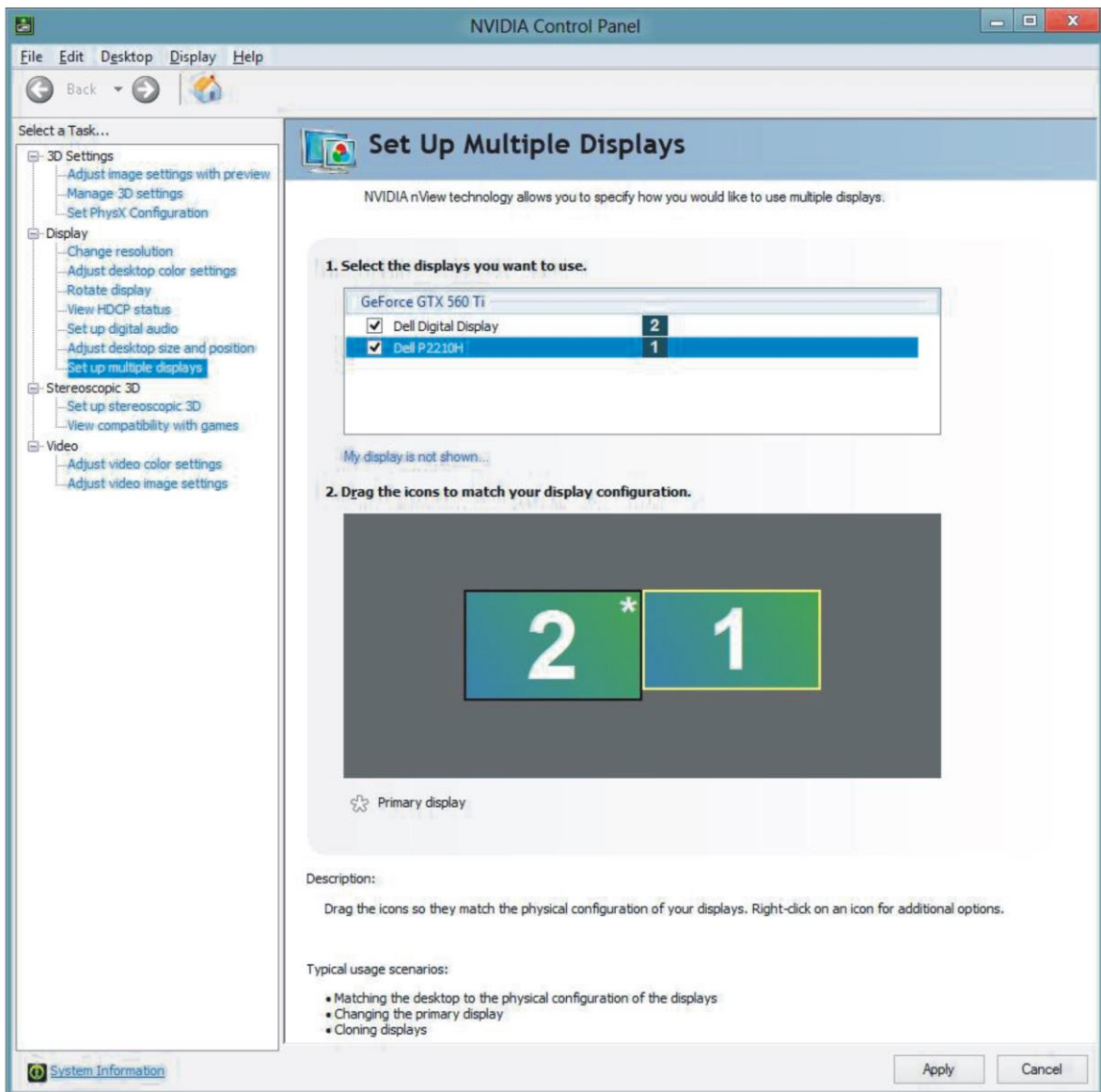

1. Download those drivers and install them.
2. Open the NVIDIA Control Panel by right-clicking the desktop and choosing NVIDIA Control Panel
3. Click the Set up multiple displays link in the left pane and follow the procedure outlined above to mimic the monitors' positioning.

3.5 System software configuration

1. Connect the data cable from sending card to the cabinet, clone the graphic card, power on the panel, then every cabinets should be working and showing the same image—or showing one part of the desktop in disorder. If the cabinet is not working, first please check if power is turn on and power cable are connect well. Then check if the green LED on receiving card whether flicker quickly or not, if it flickers very slowly, please check the data cable connection till the green lights is flashing. Once it's done, open NovaLCT , we will get a window as below:

2. Click “User —> Advanced Login”

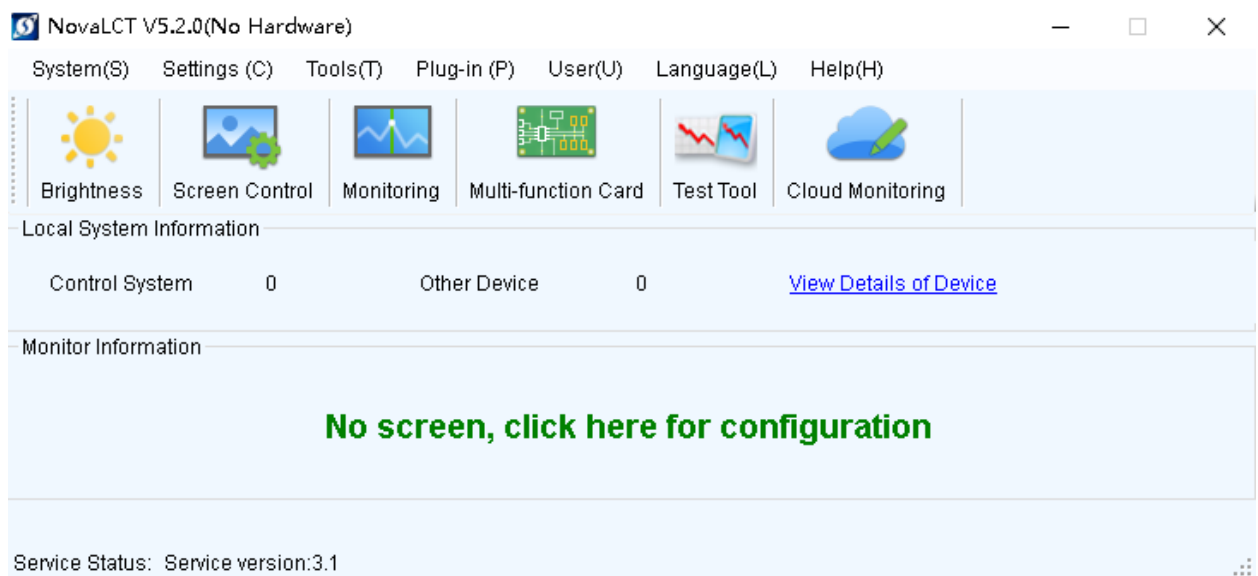

3. And then will appear a dialog box, “User Login”



4. Then input the password “666”

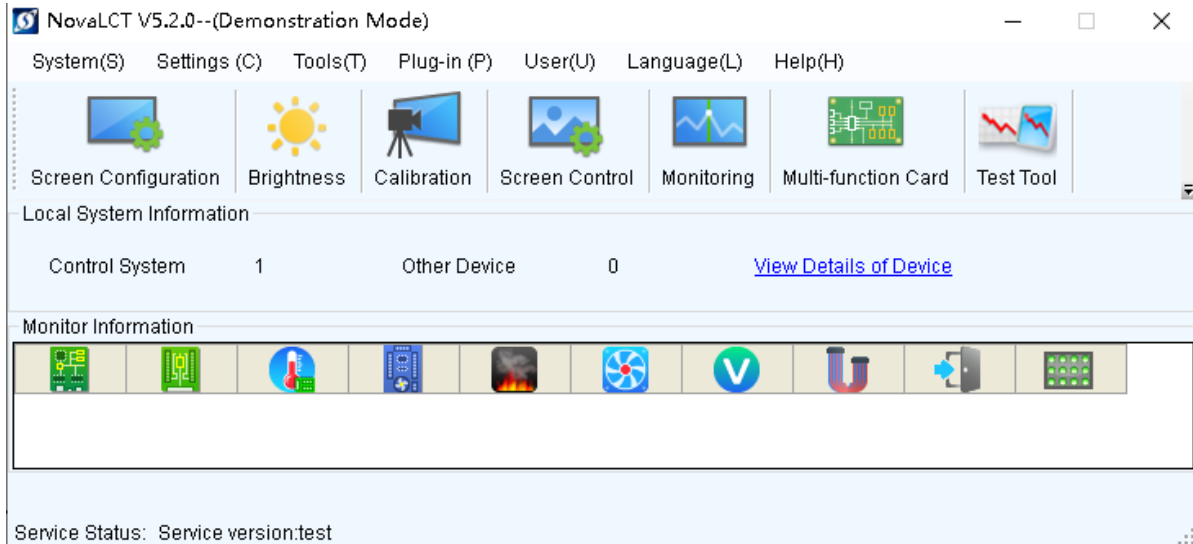

5. Click “Screen Config”

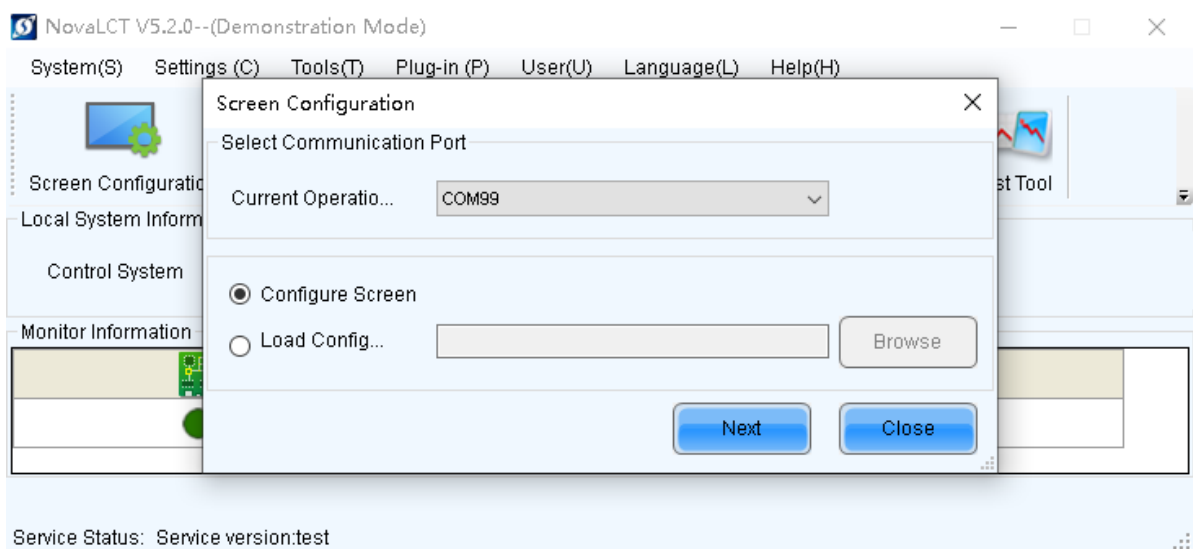

6. Click “Next”, Come to the window of “Screen Config”, including “Sending Card”, “Receiving Card” and “Screen Connection”. Click “Sending Card”, set “Resolution” and “Refresh Rate” the same with your graphic card. Then click “Save” ->”Ok”

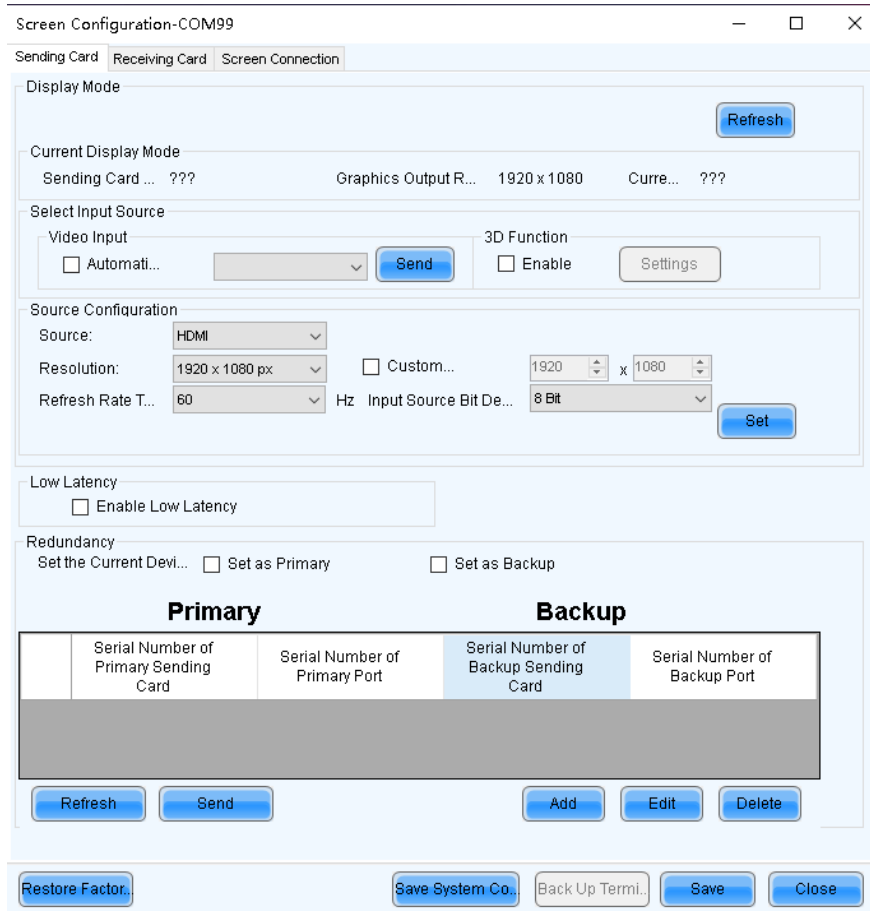

7. Click “Receiving Card” -> “Load File”, load the right *.rcfg file, then click “Send to Receiving Card”

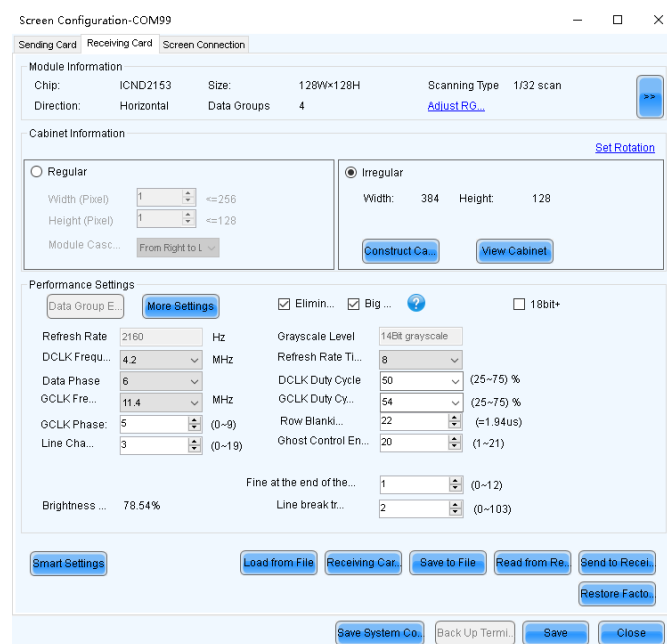

8. Then select “All Receiving Cards” -> “Send”

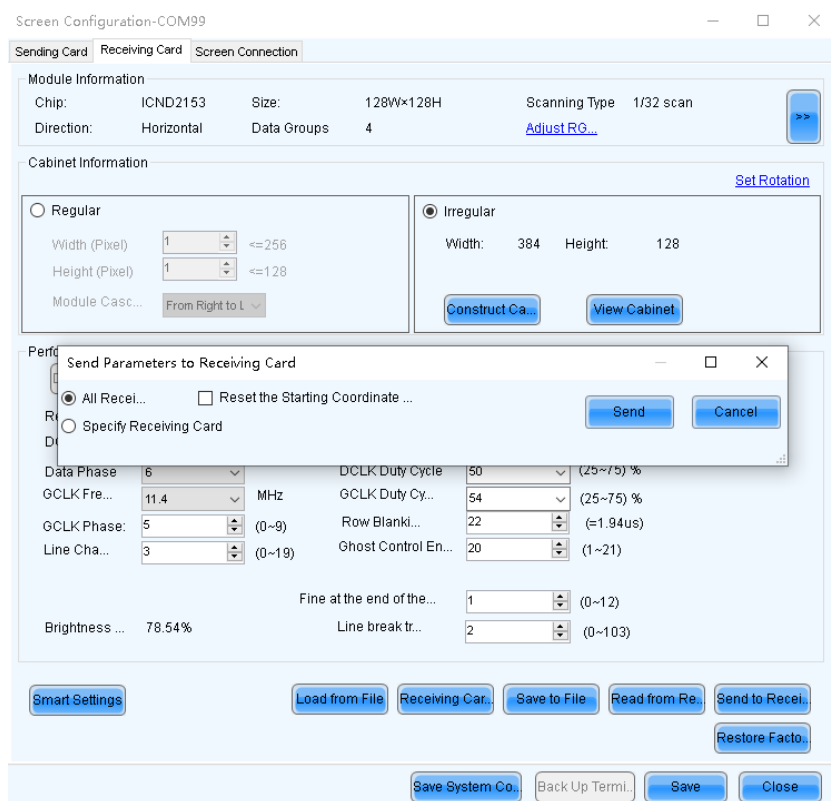

9. Click “Screen Connection” ->Screen Number : select “1”.Then select “Standard Screen” .If we have 5 screens for example, then we need to change the “Receiving Card Columns” number to 5. And then connect them in the order they are installed

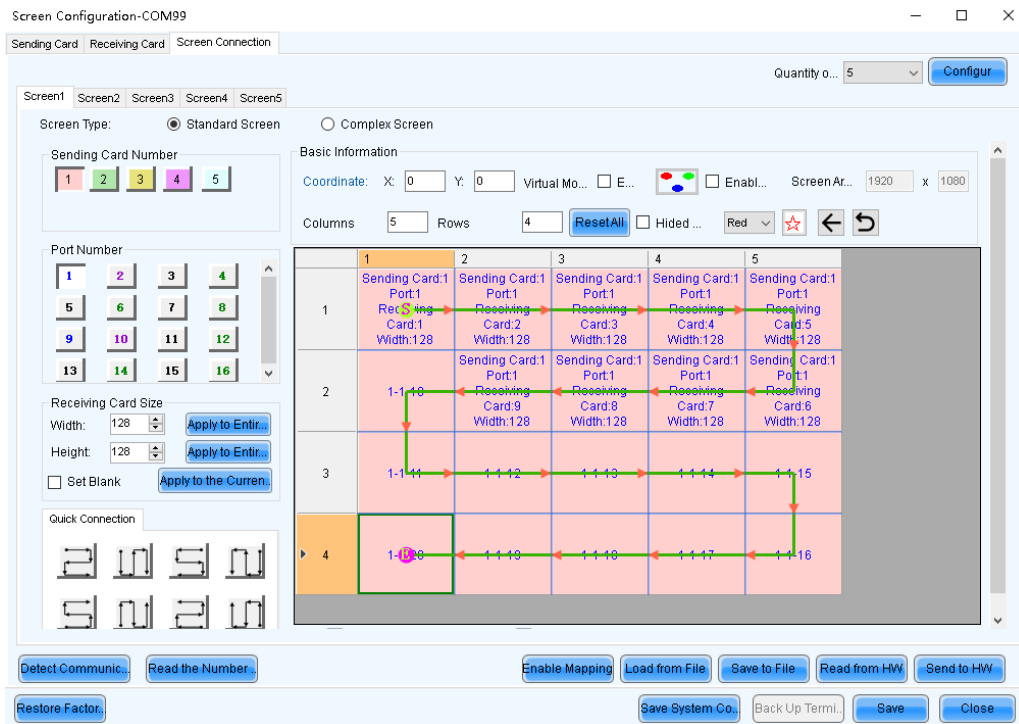

10. Click "Send to HW" -> "Save"

3.6 Quick operation with Nova studio

1. Install the Nova Studio by click the icon



2. Select the English language. Then click "OK"

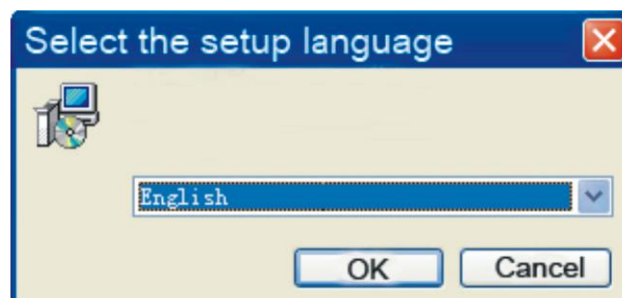

3. Click “Next” four times



4. Click “Install”

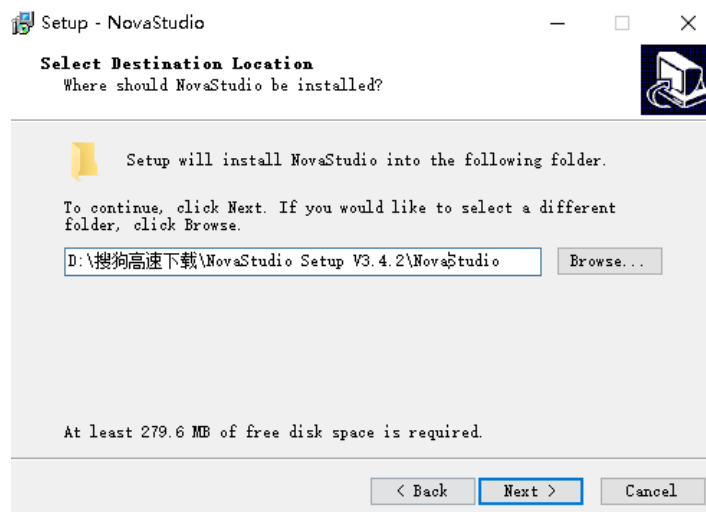

5. Click “Finish” and then the “Nova Studio” will be installed

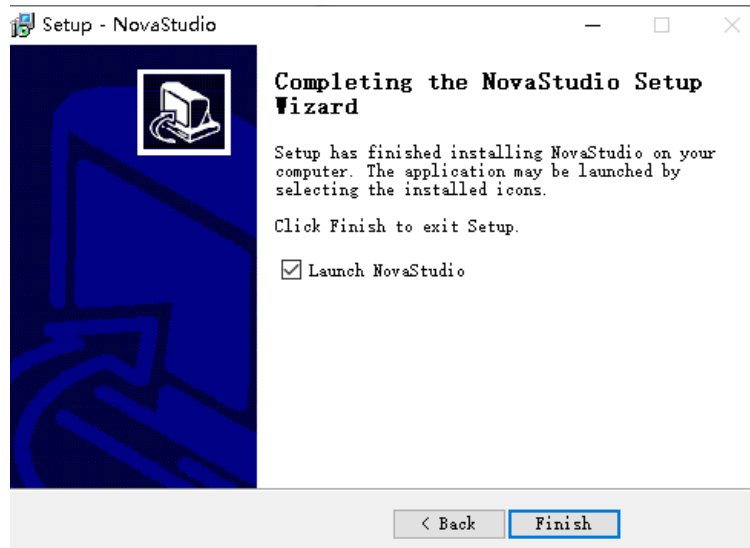

6. Click the icon , we will get two windows as below:

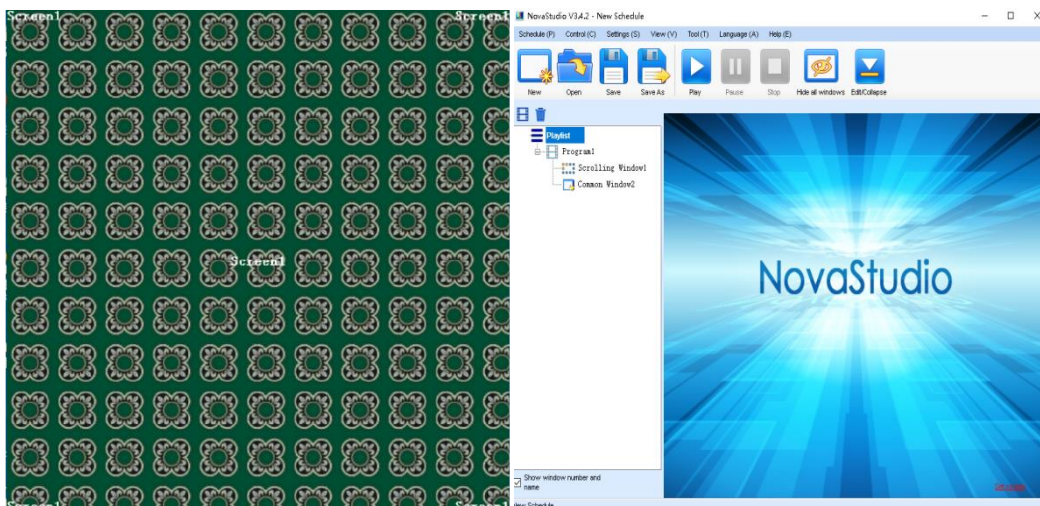

7. Click “Settings” -> “Display Settings”, come to the following window:

Count of Display Screen: 1

Start X: 0, Width: set according to the field installation

Start Y: 0, Height: set according to the field installation

Click “Ok”

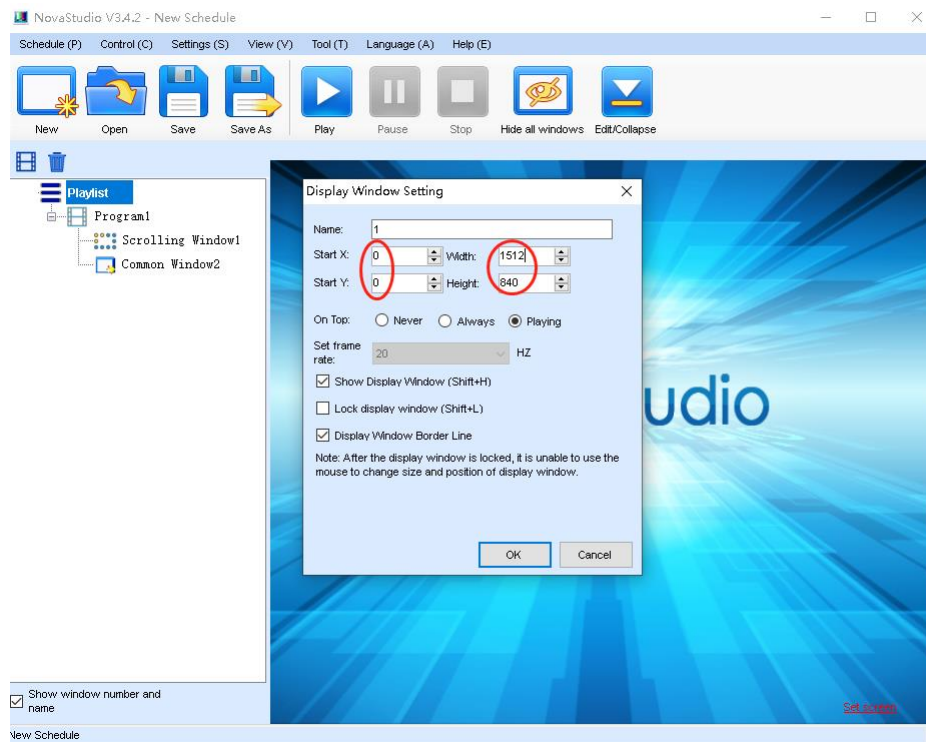

8. Click “Add Programs”, then select “Empty Page”

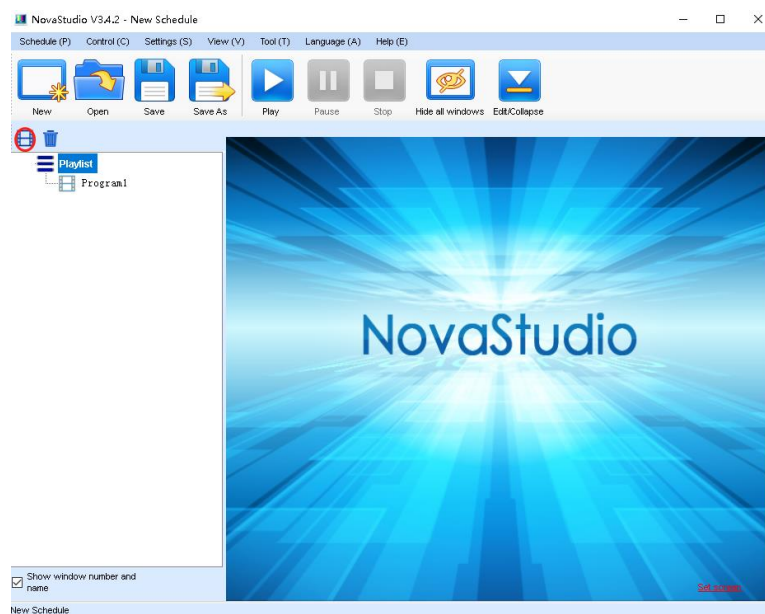

9. Select “Single window”, then click “Add”

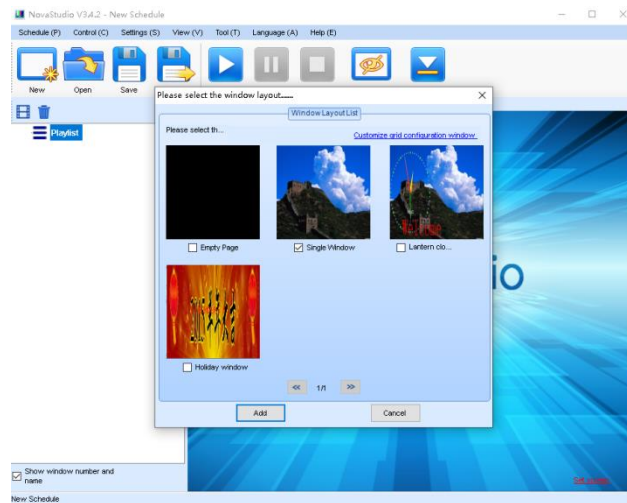

10. Click “page 1.1”, then click “Add media”, select “file”, open the right video file.

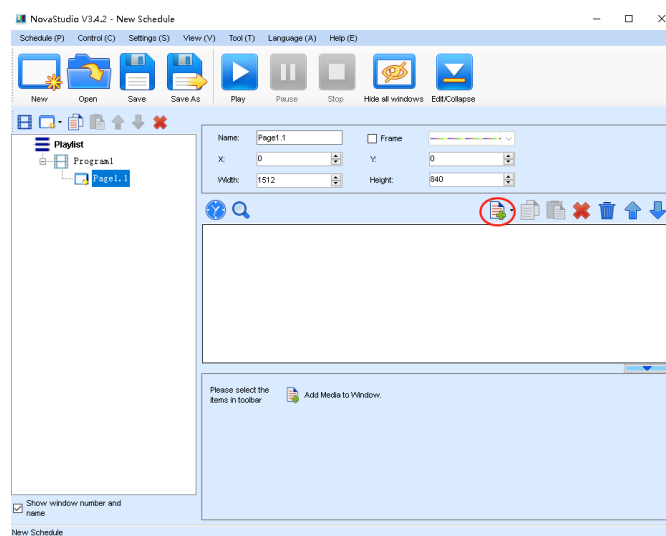

11. Then you can control you display with  button

4、 Product Installation



Warning: Safety first. Create an installation area before starting to install the display.
Make sure that you read, understand and follow all of the "safety" tips or instructions in this Manual. In addition, all installation requirements for the display must be met. See the "Installation Requirements".

4.1 Installation of Display Cabinet

1) Steps for installing the display cabinet

Step 1: Open the top cover of the outer packaging of the cabinet and move out of the cabinet.

Step 2: Unpack the anti-static plastic bag/moisture-proof plastic bag and check the appearance of the cabinet for damage.

Step 3: Unpack the cabinet, and check all the screws, cables, and power cables for looseness or detachment.

2) Precautions during installation

A. Handle the cabinet with care, and put a protective layer (paper or carpet) on the ground to prevent bumps, scratches, falls, etc.

B. When installing the cabinet, it is absolutely not allowed to hit the cabinet with iron items such as iron hammers, or construct in barbaric manners such as kicking.

C. When installing the cabinet, if the gap between the two cabinets is too large, it can be padded with hard objects to ensure the parallelism and verticality (Note: The gap between the cabinets should be less than 0.1mm).

4.2 Testing of the Screen Power Supply System (the power supply in the power distribution cabinet and the cabinet needs to be tested by the inspectors with electrician knowledge)

A. Test the L wire, N wire and ground wire (FG) for short circuit.

B. Test the N wire and ground wire (FG) for short circuit, and the resistance should be ∞ .

C. Test the receiving card +4.2V power supply and GND (30~50 Ω), ground wire (FG), L wire, and N wire for short circuit, and the resistance should be ∞ .

- D. Test the receiving board GND, ground wire (FG), L wire, and N wire for short circuit, and the resistance should be ∞ .
- E. Test each power supply output +4.2V and GND for short circuit, and the resistance should be 30~50 Ω .

4.3 Precautions for Display Installation

- A. After the display screen is installed, the screen body is protected against lightning strikes. The main distribution input terminal is connected with an arrester.
- B. The display is strictly prohibited from operating with electricity.
- C. The sending system does not support hot swapping. Be sure to unplug the power cord before plugging in the connections between various devices.
- D. It must be fixed firmly during the process of fixing the cabinet. Meanwhile, the cabinet is prevented from colliding during the fixing process, causing damage to the display product.
- E. Workers should take safety measures during the installation process (wearing protective helmets, safety belts, etc.).
- F. When disassembling the control system board and other equipment, it is necessary to prevent static electricity (wear anti-static gloves, etc.).

Installation instructions

- A. This product is only suitable for indoor installation and the installation environment is between 0 and 40 degrees. Do not install on top of a hot object or on top of a stove, as this may cause damage to the product.
- B. In order to ensure your safety, the installation of this product must be performed by a professional.
- C. Cut off the power supply before installing the product, check whether the insulation of the power supply circuit of the product is intact, and ensure that the local voltage is consistent with the rated voltage of the display screen. If it is not used for a long period of time within the rated voltage range, it may cause overheating of the product and thus cause damage.
- D. Ensure the reliability of the product and installation connections. Make sure that the connection is reliable before installing the product to prevent potential safety hazards.
- E. Be careful during the installation operation. The safety of the support and the installer must be ensured to prevent the center of gravity from falling down.
- F. Be sure to install the ground wire.
- G. Non-professionals should not open for repairs.

Precautions for installation

For other questions in the operational process, please refer to our relevant instructions. If you have any

further questions, please contact us. The above considerations are not comprehensive, and will be supplemented later in the course of use. We also hope that you can make more suggestions to jointly maintain and use the display.



Warning: The fixed objects (such as screws) and quantities are for reference only. The installer should determine the appropriate fixtures and quantities based on the actual installation environment.

5 Product Maintenance

5.1 Module Disassembly and Assembly

The product is equipped with a special module maintenance tool: magnetic suction tools or negative pressure tools.

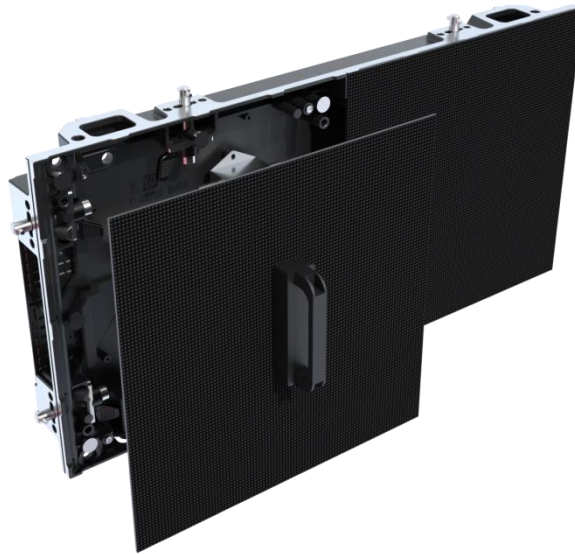

Attention: Use the maintenance tool gently and slowly to avoid damage to the lamp surface caused by sudden strong contact with the lamp surface.

Module disassembly:

1. Place the maintenance tool close to the module lamp surface that needs to be removed.
2. Hold the handle of the maintenance tool and move the maintenance tool vertically with the module surface, move backward to suck the module out.
3. Grab the module with the other hand, loosen the handle of the maintenance tool, remove the module, and lay it flat on a soft surface.

Module assembly:

1. Align the positioning pin on the module with the corresponding hole on the cabinet.
2. The module is vertically moved to the assembly surface of the cabinet at a slow speed to complete the assembly.

5.2 Disassembly and assembly of power supply and receiving card

Power supply, receiving card and HUB board can be maintained from front.

Power maintenance: the power supply is fixed with screws. First, remove the fixing screws of the power wire, then remove the power batten screws and take down the power batten to maintain the power supply;

Maintenance of receiving card: remove 4 fixing screws to remove the receiving card;

Maintenance of HUB board: after removing the receiving card, remove the screws fixing the adapter plate to directly remove the HUB board.

Installation of power supply: screw the power supply with the power batten and screws, and then connect the wire;

Installation of receiving card: lock screws for fixing;

Installation of HUB board: install four screws for fixing the adapter plate. The job is completed after the HUB board are installed.

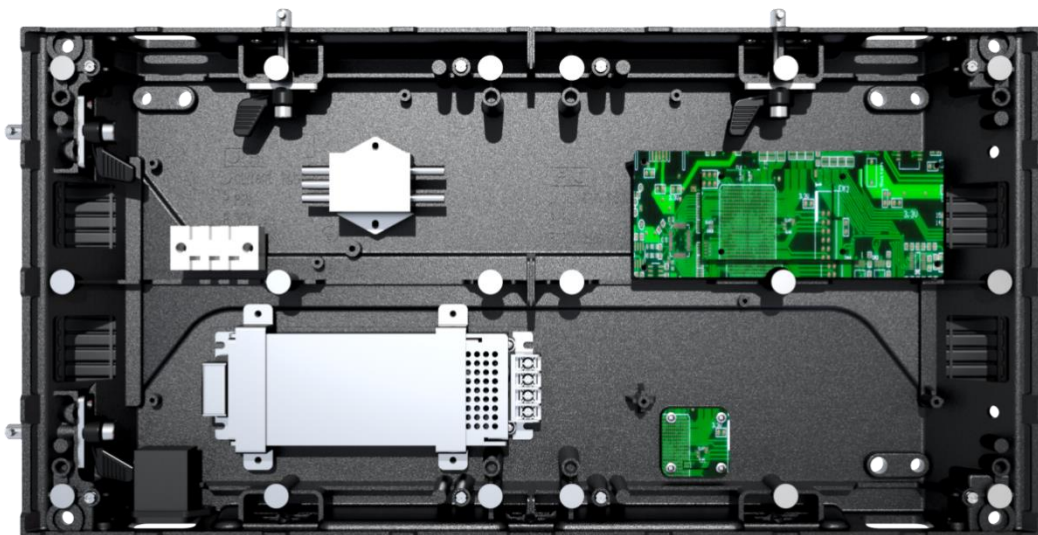

5.3 Precautions for Daily Maintenance of the Display

With the full spread of LED displays in the market, many consumers often overlook the daily maintenance of the display. Long-term use not only affects the user's visual experience, but also shortens the life of the display. Please pay attention to the daily maintenance of the LED display.

1、 Avoid being hurt by hard objects

If the LED display is accidentally damaged or scratched by hard objects, this display will be damaged. Therefore, be careful not to let the hard object damage the screen of the LED display.

2、 Do not let water or iron powder into the screen.

It is strictly forbidden to let water, iron powder and other easily conductive metal objects into the LED display screen. LAMP Tech also recommends using LED displays in a low-dust environment. Dust will have a great impact on the display effect, and will cause damage to the circuit. In case of water ingress for various reasons, immediately disconnect the power and ask for maintenance personnel. The display can be used only after drying.

3、 Moisture-proof and temperature requirements are as follows: At the highest operating temperature, the ambient humidity should be less than 60% of the relative humidity.

The temperature should be appropriate, and the temperature requirements are as follows: The operating ambient temperature is $0^{\circ}\text{C} \leq T \leq 40^{\circ}\text{C}$, , and the storage ambient temperature is $-40^{\circ}\text{C} \leq T \leq 60^{\circ}\text{C}$.

5.4 Cleaning of Fixed Display Panel



Warning: Isopropanol (200-661-7)

Dangerous goods, irritating to eyes and skin. Always use in areas with good ventilation. Steam can cause drowsiness and dizziness. Avoid contact with skin and eyes. If it accidentally comes into contact with your eyes, rinse immediately with plenty of water and seek medical advice.



Warning: Isopropanol (200-661-7)

Dangerous goods, flammable. Always use in areas with good ventilation. Keep away from fire. Smoking is prohibited when operating with isopropanol. Store in a well-sealed, original container in a cool, well-ventilated, and fire-resistant storage space.



Attention: The LED components used in the fixed display are susceptible to ESC (electrostatic discharge) damage. In order to avoid damage to the LED, take the necessary precautions.

DISPLAY A BETTER WORLD FOR ALL

Necessary Tools

1. Air compressor.
2. Isopropanol.
3. Antistatic damp cloth.
4. Vacuum cleaner.
5. Mild detergent.

Clean the exterior of the display fixing plate

1、 Turn off the display

Use compressed air to blow off dust from one side of the display (LED indicator). A safe distance of 10cm is maintained between the nozzle of the compressor and the LED indicator.

2. Clean one side of the display (LED indicator) with a damp cloth. Clean the LED indicator with isopropanol as the solvent.
3. Use a vacuum cleaner to clean the dust from the ventilation grille of the module and control cabinet.



Warning: Make sure that the area is well ventilated. Smoking is prohibited when operating with isopropanol.



Attention: Do not use a brush to clean the LEDs to avoid scratching.



Attention: The LED components used in the display are susceptible to ESC (electrostatic discharge) damage. In order to avoid damage to the LED, take the necessary precautions.



Attention: Do not use a vacuum cleaner to clean the display side (LED indicator) due to ESD.



Attention: Do not push hard or sharp objects onto the LED soft lens to avoid damaging the LED. The maximum load allowed on the LED soft lens is 300g/LED.



Tip: Use a soft brush nozzle to avoid scratching.

- Clean the casing of the rental frame and control cabinet with a damp cloth. You can use a slightly damp cloth and a mild detergent to remove stubborn stains.

Clean all display panels of the LED display each time to avoid the difference in brightness between the cleaned and uncleaned display panels.

It is recommended to use a vacuum cleaner to regularly clean the dust from the ventilation grille, modules and control cabinet. Therefore, use a vacuum cleaner with a soft brush nozzle.

Pay special attention when using or maintaining the display:



Before turning on the power switch, please check if the local AC power supply voltage meets the requirements of this product.



Do not touch the power supply when the power switch is not turned off.



Please turn off the power supply before performing any maintenance, including all switches including LED display and computer terminal monitor.



In order to prevent electric shock, please make sure that the power cable is connected, the grounding wire is correct, and the connection is in good condition.



Dampproof



Handle with care





Keep upright

When storing the product, be careful not to place it in a damp environment.







Pay attention to moisture. Handle with care when handling and moving, so as to avoid damaging to the product due to collision or large vibration. Pay attention to the direction when placing, and place according to the marked direction to avoid damage to the product.

- Do not press objects on cables such as power cords, signal cables, and communication cables. Cables should be prevented from being stepped on or pinched to prevent the risk of electric leakage or short circuit.
- When replacing the module of the LED display, please hook a secure rope on the module and the corresponding panel.
- Operating ambient humidity: At the highest operating temperature, the ambient humidity of the screen should be less than 80%.

- Operating ambient temperature: $0^{\circ}\text{C} \leq T \leq 40^{\circ}\text{C}$ 。
 - Storage ambient temperature: $-40^{\circ}\text{C} \leq T \leq 60^{\circ}\text{C}$ 。
 - The power supply must meet the requirements:
 - ① LED display's power supply voltage: $110\text{V} \sim 220\text{V} \pm 10\%$; Frequency: $50\text{HZ} \sim 60\text{HZ} \pm 5\%$
 - ② When the total power of the LED display is less than 5KW, it can be powered by a single-phase voltage; when it is greater than 5KW, in order to distribute the current evenly, it is necessary to be powered by a three-phase five-wire voltage.
 - ③ The ground wire must be in reliable contact with the earth and properly separated from the N wire. The power supply to be connected should be kept away from high-power electrical equipment.
 - When there is dust on the mask of the module, please clean it in time to avoid local color cast of the display.
 - When maintaining the display, all the removed screws should be installed back to avoid water leakage of the display cabinet.
-  • Meaning of the logo: The equipment with this logo is designed and evaluated only at an altitude of 2000m. Therefore, it is only suitable for safe use at an altitude of less than 2000m, and may have potential safety hazards when used at an altitude of more than 2000m.
-  • Meaning of the logo: The equipment with this logo is designed and evaluated for safety only in non-tropical climates. Therefore, it is only suitable for safe use in non-tropical climates. When used in tropical climates, there may be safety hazards.
- If the steel structure of the screen body is relatively closed, it is necessary to consider the ventilation and heat dissipation of the screen body and increase the ventilation equipment. Do not exhaust the indoor warm air into the screen body.

5.5 Daily Maintenance of the Screen

Personnel protection:

	<u>Warning: Be sure to understand and follow all safety guidelines, safety instructions, warnings, and precautions in this Manual.</u>
	<u>Warning: Any maintenance or repairs must be made with the power turned off and all tools and equipment must be grounded.</u>
	<u>Warning: Pay attention to the suspended load.</u>
	<u>Warning: Be careful when the load is heavy.</u>
	<u>Warning: Please operate carefully when the load is heavy to avoid finger injury.</u>
	<u>Warning: Wear a safety helmet to avoid personal injury.</u>

Precautions for safety

- Use a striking fence and a “No Entry” mark to block a restricted area at least 3m around the LED screen, preventing unauthorized personnel from accessing the LED display during the repair process.
- Check whether the entire LED display is safe and reliable, and check for wear, deformation, corrosion, and other conditions that may affect the load handling capabilities of the parts.
- Do not modify and/or copy any components. LAMP Tech uses special materials and manufacturing processes to achieve the required part strength. Any parts other than LAMP Tech parts are not allowed.
- You must rely on your hands to repair the LED display. Therefore, it is forbidden to use a ladder to access the display panel, only scaffolding or Z-lifts are allowed.

Common maintenance tools



Electric screwdrivers: Used to install and remove screws of various specifications.



Screwdriver: Used to install and remove the screws and nuts.



Multimeter: Used for testing during repair or maintenance.

5.6 Common Troubleshooting

5.6.1 Method for problem determination

The problems must be determined on a priority basis. Deal with the obvious and serious problems first, and the minor ones later. Short circuit shall be of highest priority.

1. Resistance detection method: Adjust the multimeter to the resistance level. Detect the resistance at a point on a normal circuit board. Then, check whether the resistance value tested at the same point of the same circuit board is different from the normal resistance value. If it is different, the scope of the problem will be determined.
2. Voltage detection method: Adjust the multimeter to the voltage level. Detect the voltage at a point in the circuit suspected of having a problem and compare whether it is similar to the normal value. If not, the scope of the problem will be determined.
3. Short-circuit detection method: Adjust the multimeter to the short-circuit detection level (some are diode voltage drop level or resistance level, with general alarm function). Test for short circuit. After the short circuit is found, it should be solved first, so that it does not burn other devices. This method must be operated in the event of a power failure to avoid damage to the multimeter.
4. Voltage drop detection method: Adjust the multimeter to the diode voltage drop detection level. Since all ICs are made up of a large number of basic cells, they are only miniaturized. Therefore, when there is current on one of its pins, there is a voltage drop across the pin. Generally, the voltage drop across the same pin of the IC of the same model is similar. According to the voltage drop value on the pin, it is necessary to operate under the condition that the circuit is powered off. This method has certain limitations. For example, if the device under test is of high-resistance, it will not be detected.

5.6.2 Common faults of LED display and its troubleshooting

1. The entire screen is not lit (blank screen)

A: Check the power supply of the screen. Use a screwdriver with voltage tester or a multimeter to check if there is power at the electrical appliance. There may be a problem with the switch or it may be broken.

B: For displays that are synchronized with the computer, first check if the computer enters dormant state or screen saver state. In case of in dormant state, first enter the "Control Panel" to click "Power Management", then select the "Never" option for the "System Waiting" and "Close Monitor" options, so that the computer will not enter the dormant state and the display will function normally. In case of not in dormant state, you can open the case to check whether the control card and communication cable are firmly connected, and check whether the communication cable is disconnected, which can basically solve the above problems.

C: Check whether the communication cable is connected, and check for errors and synchronizing panel. Please follow the connection diagram to connect and check.

D: Check if the green signal indicator of the sending card is flashing.

E: Check if the graphics card settings are normal and the FPD is turned on.

F: Check if the signal indicator on the receiving card is flashing normally.

2. The whole unit board is not lit (blank screen)

A: If several consecutive boards are not in the horizontal direction, check whether the connection between the normal unit board and the abnormal unit board is connected. If several consecutive boards are not lit in the vertical direction, check if the power supply of this column is normal.

B: Check if the position of a receiving card is not lit, check if the receiving card voltage is 5V, and whether the network cable input to the receiving card is normal.

C: If a unit board is not lit, check if the cable input to the unit board is loose.

3. Incomplete display file or incorrect position

A: First check whether the parameters of "display position" and "screen size" in the software are consistent with those given in the installation project. If you don't remember, you can count the number of pixels in the length and width on the screen. After the "screen size" is determined, you can see how much difference is displayed on the screen, and then go back to the computer and adjust it until the position is consistent.

B: In case of incomplete display, check if the file size is the same as the "screen size" of the screen.

C: Open the case and check if the conductor is dropped on the control card.

4. Communication display is not available for communication

A: Check if the parameters in the software are consistent with the installation project.

B: Check if the serial port is connected and if the communication cable is disconnected.

5. The display is jittery, with horizontal stripes:

Check if the common ground wire connected to the computer is loose, or if the communication cable is loose. If the operator cannot determine the cause of the problem or is not familiar with the computer, do not open the case easily. If the problem of the display is very serious, please contact us in time, and then diagnose with the consent and instructions of our staff.

6. No sound on the screen

It is because the sound controller that comes with the graphics card conflicts with the sound controller in

the computer. Turn off the sound controller in the computer. The operation is as follows: Open the "Attributes" of My Computer, find the "Device Manager" in "Hardware", select the sound controller, and then disable "Realtek high definition Audio".

7. Fail to play DVD or video files

A: The computer does not have a video file player installed.

B: This file format is not supported by the player itself.

C: You can install WINDVD or POWER player.

8. Display screen blurring or flashing

A: Check if the DVI cable is plugged in.

B: Check the network cable for short circuit or disconnection.

C: Check if the screen refresh rate of the monitor is set at 60HZ.

D: Check if the transmission distance of the network cable is too long and thus cause flashing.

9. Output problem

A: Check if the cable from the output interface to the signal output IC is connected or short-circuited.

B: Check if the clock latch signal of the output port is normal.

C: Check whether the cascaded output data port between the last driver IC is connected to the data port of the output interface or is short-circuited.

D: Check if the output signals are short-circuited to each other.

E: Check if the output cable is in good condition.

10. The display is confusing and the output is abnormal.

A: Check if the clock CLK latch STB signal is short-circuited.

B: Check if the clock CLK of 245 has an input or an output.

C: Check if the clock signal is short-circuited to other cables.

Note: It mainly detects clock and latch signal.

11. The display is confusing, but the signal output to the next board is normal.

A: Check if the STB latch output terminal corresponding to the 245 is connected to the latch terminal of the driver IC or the signal is short-circuited to other circuits.

B: Check if there is an open circuit or a virtual soldering or short circuit between the A, B, C and D output terminals corresponding to 245 and 138.

C: Check if there is a short circuit between the signals of A, B, C, and D or a short circuit between a signal and ground.

Note: The ABCD line signal is mainly detected.

12. Display lack of color

A: Check if the data terminal of the color of 245 has an input and output.

B: Check if the data signal of this color is short-circuited to other circuits.

C: Check if the cascade data port between the driver ICs of this color has an open circuit or short circuit or a virtual solder.

Note: It is easier to find the problem by means of voltage detection. Check whether the voltage of the data port is different from the normal voltage and thus determine the fault area.

6. Description on After-sales Services

6.1 Pre-sales Services (Technical Consultation)

LAMP Tech provides pre-sales consulting services to its customers. The main purpose of pre-sales services is to assist customers in engineering planning and system requirements analysis, so that our products can meet the needs of users to the greatest extent, and at the same time enable customers to maximize the overall economic benefits.

6.2 After-sales Services

Shenzhen LAMP Tech has established a complete engineering file for each project, has a technically competent engineering team, and is equipped with professional maintenance personnel to provide customers with after-sales services and respond to customer needs. We provide a free warranty and lifetime warranty for all products that have already been delivered. During the free warranty period, all faults caused by component quality or production and installation processes can be unconditionally repaired free of charge. However, the failure caused by violation of the regulations or some irresistible external factors (such as power supply parameters exceeding the standard, lightning strikes, etc.) is not included in the free warranty, and the service fee is charged as appropriate.

一、 Warranty period:

The product is warranted for one year from the date of shipment from the factory. During the warranty period, the product is faulty and is repaired free of charge by the technical staff of the company for normal use (used in accordance with the product manual and its precautions).

二、 Warranty scope:

LED modules, switching power supplies, control systems and other major accessories (products not purchased directly from our company are not covered by this warranty).

三、 Warranty method:

Send to repair, by express mail or other means.

四、 Response speed

1. Send to repair: The repair service shall be performed within 24 hours after receipt of the repaired product and sent back to the repairer or to a trained third party authorized by LAMP Tech for repair.
2. Telephone or network: Contact the user within 2 hours and provide a solution within 8 hours.
3. On-site maintenance (only for customers in China). According to the maintenance requirements, the response shall be within 48 hours in Guangdong province and within 72 hours outside Guangdong province. In case of special circumstances, both parties shall solve the problems through friendly consultation.

五、 Product exchange and return

Our company supplies strictly according to the contract list. If the quantity or specification does not match the actual situation, the buyer may file an objection within 3 days after receiving the goods, and the equivalent value will be exchanged or supplemented after validation by our company.

六、 Accidental damage repair:

In case of improper operation or accidental damage during use, our company can provide the corresponding accessories, and only charge the cost of the accessories without any additional fees.

七、 Upgrade service:

Our products will be upgraded from time to time without prior notice. If the user needs to upgrade the product, we will try our best to provide assistance.

八、 After-sales services beyond the warranty period:

Our company only charges maintenance costs (labor fees, accessories costs, and travel expenses).

九、 Contact information for after-sales services:

Headquarters (Shenzhen)

Address: 6 Lanjing North Road, Pingshan District, Shenzhen 518118 China

Contact number: 0755-27657656

Fax: 0755-27653206

Email: postsale_service@szlamp.net

Dutch station (Eindhoven)

Address: Van Dijklaan 13C Waalre, 5581WG, the Netherlands

Contact number: +31629152912

Email: postsale_service@szlamp.net

America service center (Nashville, Alabama)

Address: 17029 Hwy 72, Rogersville, AL 35652

Contact number: +1 (239) 920-3287

Email: obu92@szlamp.net

Middle-east service center (Dubai international city)

Address: Room 304, CBD E01, International City, Dubai UAE

Contact number: +971 054 51 77886

Email: obu91@szlamp.net

- 十、 Under one of the following circumstances, no one can enjoy free repair or replacement:
- A. Unable to provide valid proof that it is LAMP Tech's product.
 - B. The serial number on the product is damaged or has traces of alteration.
 - C. Failure and damage caused by improper installation, improper use or self-disassembly.
 - D. Failure and damage caused by transportation, falling, etc. after the acceptance.
 - E. Failure or damage caused by force majeure such as fire, flood, earthquake, etc., or pollution, moisture, corrosive gases, etc.
 - F. Failure or damage caused by abnormal voltage, abnormal current, etc.
 - G. Failure or damage caused by use beyond the specified range.
 - H. Gifted products.
 - I. Failure or damage not attributable to the company.
 - J. Modification and repair by the user or disassembly, modification and repair by a third party not permitted by LAMP.
 - K. Due to improper storage or use.
 - L. Beyond the free warranty period.
 - M. Others.

Please save the warranty card, and no replacement if lost. The warranty card is only for domestic use in China. This warranty card stipulates that any part of the warranty card shall be guaranteed.

N. The company reserves the right of final modification and interpretation of the above terms.