

# INSTALLATION & OPERATION MANUAL

# inDESIGN

## BA SERIES

### POWER AMPLIFIERS

**BA460**

**BA4120**

**BA2240**

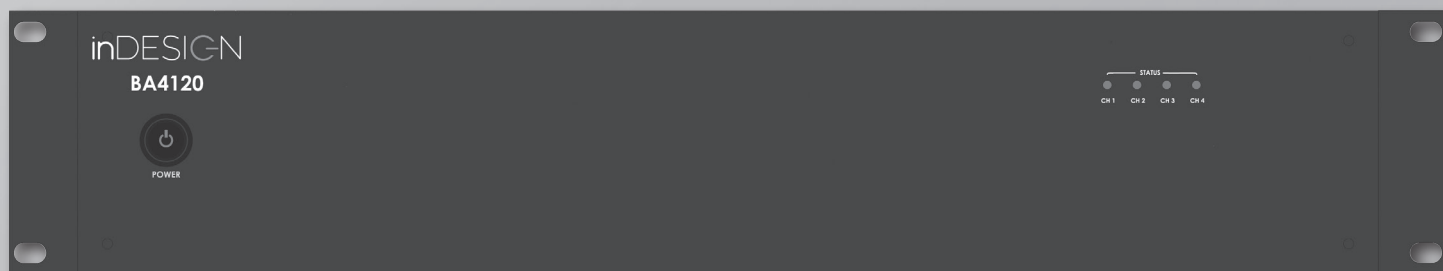

### CONTENTS

INTRODUCTION	2
IMPORTANT SAFETY INSTRUCTIONS	3
INSTALLATION	5
FRONT PANEL	6
REAR PANEL	7
BLOCK DIAGRAM	8
SPECIFICATIONS	9
WARRANTY INFO	10

### INTRODUCTION

The inDESIGN BA Series Power Amplifiers are high quality amplifiers for commercial and installed audio applications.

The BA Series Power Amplifiers provide either 4 Ohm or 100V speaker outputs.

The amplifiers are part of inDESIGN's Install Series, which also includes mixers and power amplifiers. These units provide excellent features and value.

## Electrical and Safety Warnings

### CAUTION

THESE SERVICE INSTRUCTIONS ARE FOR USE BY QUALIFIED SERVICE PERSONNEL ONLY. TO REDUCE THE RISK OF ELECTRIC SHOCK DO NOT PERFORM ANY SERVICING OTHER THAN THAT CONTAINED IN THE OPERATING INSTRUCTIONS UNLESS YOU ARE QUALIFIED TO DO SO.



The lightning flash with arrowhead symbol, with an equilateral triangle, is intended to alert the user to the presence of un-insulated "dangerous voltage" within the products enclosure that may be of sufficient magnitude to constitute a risk of electric shock to persons.

#### CAUTION



**RISK OF ELECTRIC SHOCK  
DO NOT OPEN**

**WARNING:** TO REDUCE THE RISK OF ELECTRIC SHOCK, DO NOT REMOVE COVER (OR BACK). NO USER SERVICEABLE PARTS INSIDE. REFER SERVICING TO QUALIFIED SERVICE PERSONNEL.  
**WARNING:** TO REDUCE THE RISK OF FIRE OR ELECTRICAL SHOCK, DO NOT EXPOSE THIS APPLIANCE TO RAIN OR MOISTURE.



The exclamation point within an equilateral triangle is intended to alert the user to the presence of important operating and maintenance (servicing) instructions in the literature accompanying the appliance.

**IMPORTANT SAFETY INSTRUCTIONS**

1. Read these instructions.
2. Keep these instructions.
3. Heed all warnings.
4. Follow all instructions.
5. To prevent injury please refer to these instructions for electrical and safety information before installing or operating the apparatus.
6. No naked flame sources such as lighted candles should be placed on the apparatus.
7. Operation of this apparatus is recommended for moderate climates only.
8. This apparatus must not be exposed to dripping or splashing liquid.  
No object filled with liquid, such as a vase, should be placed on the apparatus.
9. Clean only with a dry cloth.
10. Do not block any of the ventilation openings. Install in accordance with the manufacturer's instructions.
11. Do not install near any heat sources such as radiators, heaters, stoves, or other apparatuses (including amplifiers) that produce heat.
12. Unplug this apparatus during lightening storms or when not in use for long periods of time.
13.  Protective Earthing Terminal:  
The apparatus should be connected to a mains socket outlet with a protective earthing connection.
14. The mains plug/appliance coupler is used as a disconnect device, the disconnect device shall remain readily operable.
15. When not in use and during transportation, please take care of the power cord set, for example, tie up the power cord set with a cable tie/something similar. It should be kept away from sharp edges and the like that can cause abrasion of the power cord set. When put into use again, check that the power cord set is not damaged. If any damage is found, have the unit checked by a qualified service person to replace the power cord set specified by the manufacturer.
16. The terminals marked with symbol of " " may be of sufficient magnitude to constitute a risk of electric shock. The external wiring connected to the terminals requires installation by a qualified service person or the use of ready-made leads or cords.
17. Only use attachments/accessories specified by the manufacturer.
18. Check speaker line load prior to connecting to amplifier using an impedance meter.
19. Refer all servicing to qualified service personnel. Servicing is required if the apparatus has been damaged in any way, such as power-supply cord or plug breakage, damage due to liquid or objects falling onto the apparatus, exposure to rain or moisture, or if the apparatus does not operate normally, or has been dropped.
20.  Correct Disposal of this Product:  
This marking indicates that this product should not be disposed of with other household wastes. To prevent possible harm to the environment or human health from uncontrolled waste disposal, recycle it responsibly to promote the sustainable reuse of material resources. To return your used device, please use the return and collection systems or contact the retailer where the product was purchased. They can take this product for environmental-safe recycling.

**WARNING:** There are no user serviceable parts inside. Refer all servicing to qualified service personnel.

**You must allow a minimum 10 cm or 4 inches of unobstructed clearance around the unit.**

Do not place the unit on a bed, sofa, rug, or similar surface that could block the ventilation openings. If the unit is placed in a bookcase or cabinet, there must be ventilation of the cabinet to allow proper cooling.

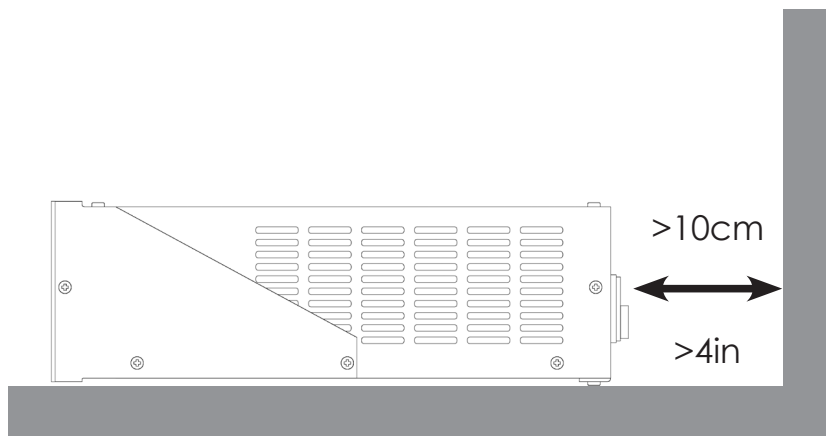
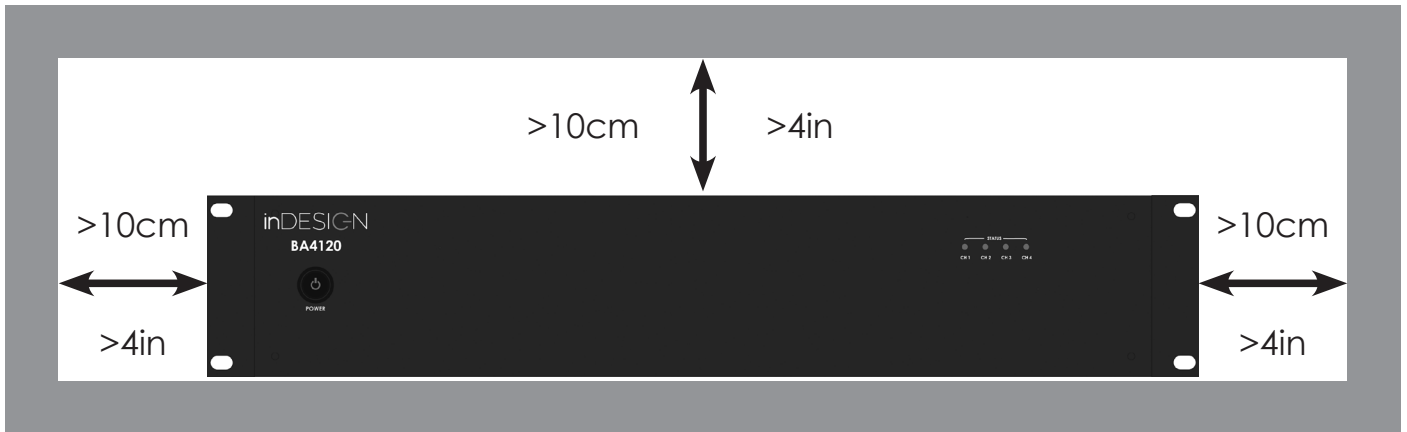

**INSTALLATION****How to Calculate the correct load for a 100V Amplifier:**

When installing a 100V loudspeaker system it is rather simple to calculate the number of loudspeakers that can be connected to a particular 100V amplifier.

Each 100V loudspeaker has a 100V transformer that will have different power tapings, for example 1.5, 3 and 6W. The sum of all taps should never exceed the amplifiers power rating.

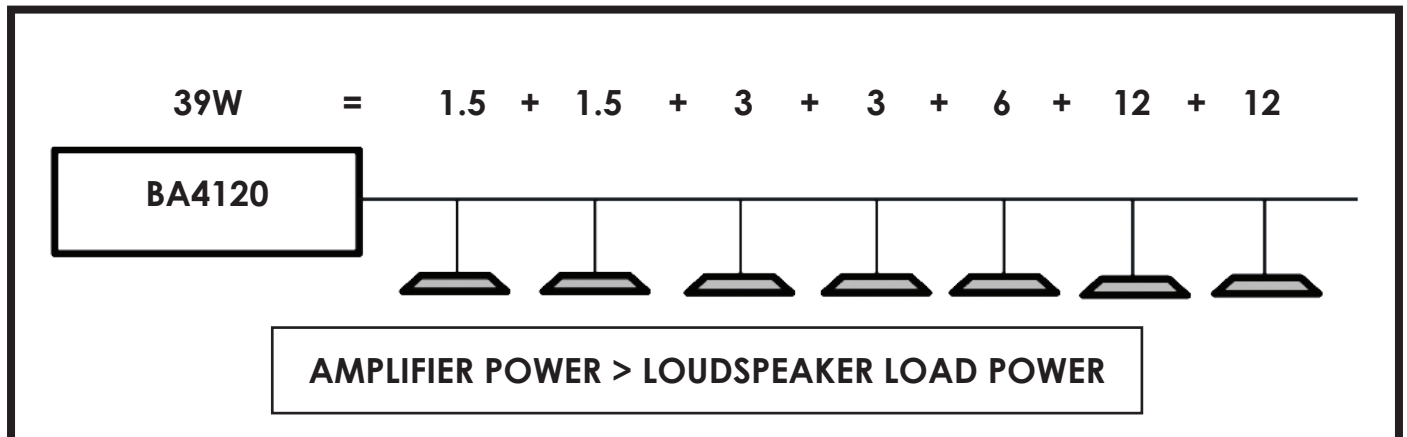
**To calculate the amplifiers capability:**

If your chosen amplifier has a maximum output of 120 Watts at 100V, the minimum impedance connected should be at least 83 Ohm ( $100V \times 100V / 83 \text{ Ohm} = 120W$ ).

Use a professional impedance meter, not a Multimeter.

## FRONT PANEL



- 1. Power Switch:** Turns mains power on and off.  
The LED light above the switch indicates the unit is on/off.
- 2. Level Indicator:** To set for optimum working level normal signal should be kept under the 0dB.  
The red +3dB will illuminate when signal is excessive.

## REAR PANEL

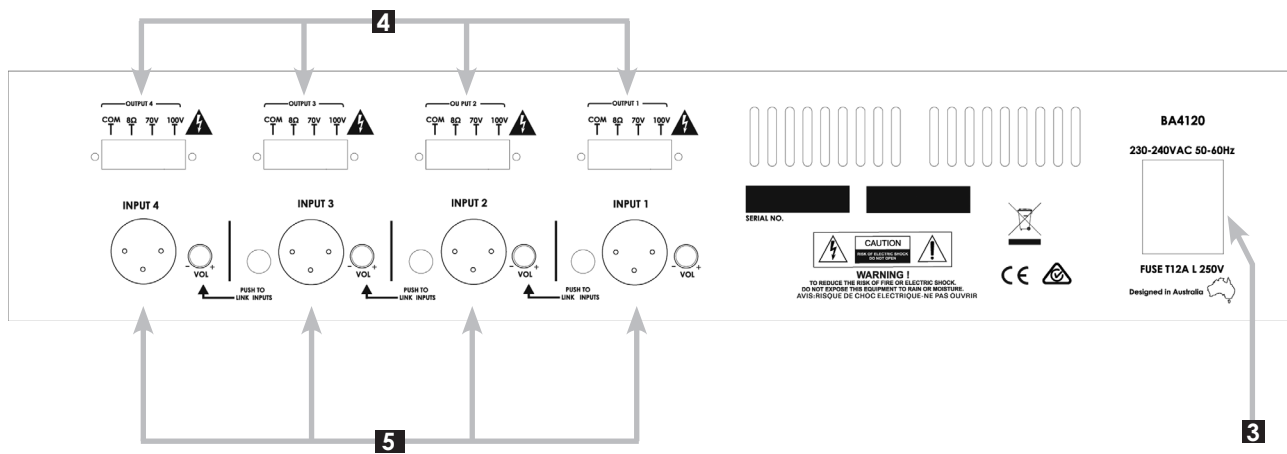

**3. Mains Socket:** The unit is connected to the mains circuit with a standard IEC type power lead. This socket contains a rated slow blow fuse.

**\*\*NOTE: Only use a fuse equal to the marked rating.**

- **BA4120** uses a fuse with a **12A** rating
- **BA460** uses a fuse with an **8A** rating
- **BA2240** uses a fuse with a **12A** rating

**4. Loudspeaker Outputs:**

When connecting low impedance loudspeakers use the COM and 8Ω connections.

For 70V and/or 100V loudspeakers use the COM and 70V or 100V connections.

For 70V or 100V operation, the total minimum impedance of the loudspeaker lines should not overload the amplifier. Refer to the above installation guide for how to calculate the loudspeaker load or measure with an impedance meter.

Use only one of the loudspeaker connections. Do not combine both 8Ω and 70V/100V loudspeaker connections.

**5. Input Connector and Channel Link Switch:**

Press switch to link channel 1 input signal to channel 2/3/4.

# BLOCK DIAGRAM

## BA Amplifier Block Diagram

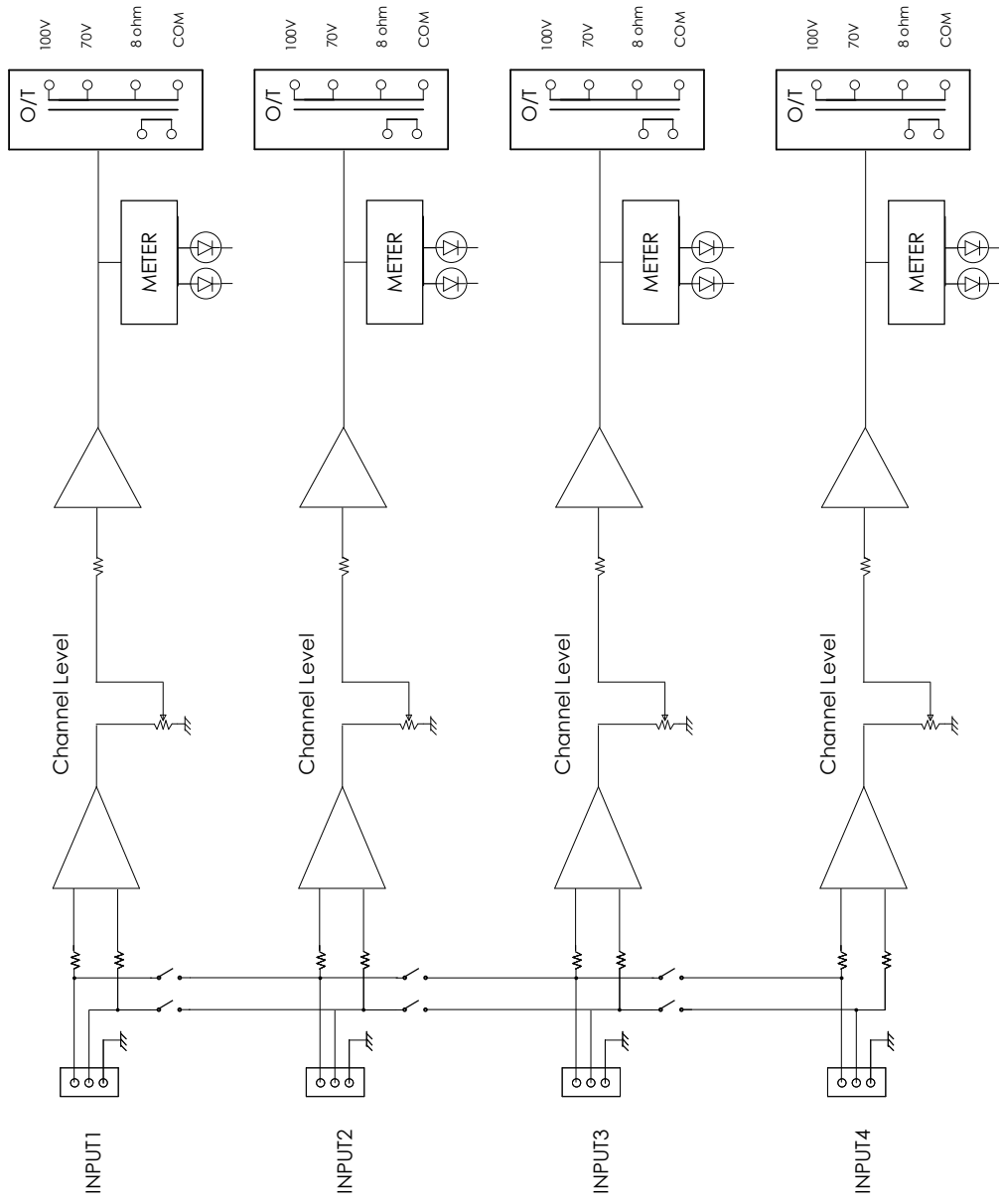



## SPECIFICATIONS

	<b>BA460</b>	<b>BA4120</b>	<b>BA2240</b>
<b>Output power</b>	4 x 60W	4 x 120W	2 x 240W
<b>Power supply</b>	230VAC-240VAC		
<b>Output low impedance</b>	4-8 ohm		
<b>Hi impedance output</b>	70V / 80 ohm 100V / 160 ohm	70V / 40 ohm 100V / 80 ohm	70V / 20 ohm 100V / 40 ohm
<b>Input sensitivity</b>	Balance input 1V		
<b>Frequency response</b>	50Hz-18kHz, +/- 2dB at -3dB rated power		
<b>Noise floor (at 100V)</b>	4mV		
<b>THD (100V at -3dB rate power)</b>	0.10%		
<b>Cooling</b>	Fan cooling, thermal control		
<b>Dimensions (mm)</b>	485 x 88 x 370		
<b>Net weight (kg)</b>	14	17.3	15.2

**\* Disclaimer:** *Instructions and specifications are correct at time of printing.  
Information within may be subject to change without notice.*

## WARRANTY INFORMATION – Terms of Warranty – 5 Years

### Consumer Guarantees

When you purchase a NAS Solutions distributed product, you have the peace of mind in knowing that your product is covered by the NAS warranty. The NAS warranty is provided by NAS Solutions (ABN 50 085 679 894), 127 Merrindale Drive, Croydon, Victoria 3136. ['NAS']

The Australian Consumer Law protects consumers by giving them certain guaranteed rights when they buy goods and services. Rights guaranteed under the Australian Consumer Law include;

- The goods are of acceptable quality;
- The goods match their description or any sample or demonstration model;
- The goods are fit for any represented purpose or purpose which the consumer has made known;
- Repairs and spare parts are reasonably available (unless notice has been provided that repairs or spare parts would not be available); and
- The services are carried out with reasonable care and skill and are completed within a reasonable time

These rights are called 'Consumer Guarantees' and apply automatically whenever goods or services are supplied to a consumer. These Consumer Guarantees cannot be refused, changed or limited.

Consumer Guarantees have no set time limit and depending on the price and quality of goods a Consumer may be entitled to a remedy after any manufacturers' or NAS's extended warranty has expired.

The Specific Warranty Table Information outlines the warranty period, warranty type and any specific exclusions for your NAS product. NAS considers the warranty period specified in the Specific Warranty Table to be a reasonable warranty period having regard to the price, design, manufacture and expected use of the product.

### General Warranty ('Warranty')

NAS products come with guarantees that cannot be excluded under the Australian Consumer Law. You are entitled to a replacement or refund for a major failure or if the goods fail to be of acceptable quality. You are also entitled to have the goods repaired or replaced if the goods fail to be of acceptable quality and failure does not amount to a major failure. What constitutes a major failure is set out in the Australian Consumer Law.

Subject to the terms and conditions set out below, and unless otherwise specified in the Specific Warranty Information for your NAS product, NAS agrees to repair or replace, at NAS's cost, the NAS product purchased by you in Australia or New Zealand from NAS or a NAS authorised reseller when the product does not perform substantially in accordance with the specifications during the warranty period specified in the Specific Warranty Table for your NAS product. NAS makes no other express warranties in respect of your NAS product. To make a claim under this Warranty, valid proof of purchase must be presented when the warranty claim is made, along with any other required information. The Warranty offered by NAS is not transferable.

The Warranty will only apply if your NAS product has been installed and used in accordance with NAS's recommendations as noted in the operating instructions.

### Warranty Exclusions

The Warranty does not cover damage caused by;

- Misuse or abuse of the product by You;
- Incorrect operation or not following the operation instructions (as noted in the operating instructions);
- Improper installation;
- Incorrect or improper maintenance or failure to maintain the product;
- Failure to clean or improper cleaning of the product;
- Incorrect voltage or non-authorised electrical connections;
- Adverse external conditions such as incorrect or fluctuations in electrical voltage, thunderstorm activity, acts of God, acts of terrorism, damage caused by vermin, or any other circumstance beyond NAS's control;
- Exposure to excessive heat, moisture or dampness;
- Exposure to abnormally corrosive conditions;
- Alterations or modifications to the product made by You or a third party; or
- Damage as a result of accident, liquid, grit, impact or lack of proper care as indicated in the operating instructions;
- Damage resulting from the use of cleaning solvents such as acetone

The Warranty does not apply if any serial number or appliance plate on the product has been tampered with, removed or defaced.

The Warranty does not apply if the product has been repossessed under any financial agreement.

The Warranty excludes accessories and consumable goods which have ceased working through normal wear and tear such as, but not limited to, batteries, lamps and other parts classifiable as a consumable part. **This includes the CD mechanism and laser fitted to the inDESIGN iDCDP-110. These parts carry a 3 month warranty.**

The Warranty does not cover the loss of any data howsoever caused. You shall be responsible for backing up and protecting data against loss, damage or destruction.

Products presented for repair may be replaced by refurbished products of the same type rather than being repaired. Refurbished parts may be used to repair the products. Replacement of the product or a part does not extend or restart the Warranty Term.

The product will be at the owner's risk whilst in transit to and from all NAS authorised service centres, unless transported by NAS or its authorised representatives.

NAS and its authorised service centres may seek reimbursement of any costs incurred by them when the product is found to be in good working order.

The cost of claiming under this warranty, including return of any product to NAS is to be borne by the consumer.

The Warranty excludes removal or reinstallation costs.

**\* All inDESIGN products come with a 5 year warranty term.**

For further information and warranty claims, refer to our **Support** page at [www.nas.solutions](http://www.nas.solutions)